



HIKVISION

Digital Video Recorder

User Manual

UD.6L0202D2195A01

User Manual

COPYRIGHT ©2015 Hangzhou Hikvision Digital Technology Co., Ltd.

ALL RIGHTS RESERVED.

Any and all information, including, among others, wordings, pictures, graphs are the properties of Hangzhou Hikvision Digital Technology Co., Ltd. or its subsidiaries (hereinafter referred to be “Hikvision”). This user manual (hereinafter referred to be “the Manual”) cannot be reproduced, changed, translated, or distributed, partially or wholly, by any means, without the prior written permission of Hikvision. Unless otherwise stipulated, Hikvision does not make any warranties, guarantees or representations, express or implied, regarding to the Manual.

About this Manual

This Manual is applicable to TurDVR.

The Manual includes instructions for using and managing the product. Pictures, charts, images and all other information hereinafter are for description and explanation only. The information contained in the Manual is subject to change, without notice, due to firmware updates or other reasons. Please find the latest version in the company website (<http://overseas.hikvision.com/en/>).

Please use this user manual under the guidance of professionals.

Trademarks Acknowledgement

HIKVISION and other Hikvision’s trademarks and logos are the properties of Hikvision in various jurisdictions. Other trademarks and logos mentioned below are the properties of their respective owners.

Legal Disclaimer

TO THE MAXIMUM EXTENT PERMITTED BY APPLICABLE LAW, THE PRODUCT DESCRIBED, WITH ITS HARDWARE, SOFTWARE AND FIRMWARE, IS PROVIDED “AS IS”, WITH ALL FAULTS AND ERRORS, AND HIKVISION MAKES NO WARRANTIES, EXPRESS OR IMPLIED, INCLUDING WITHOUT LIMITATION, MERCHANTABILITY, SATISFACTORY QUALITY, FITNESS FOR A PARTICULAR PURPOSE, AND NON-INFRINGEMENT OF THIRD PARTY. IN NO EVENT WILL HIKVISION, ITS DIRECTORS, OFFICERS, EMPLOYEES, OR AGENTS BE LIABLE TO YOU FOR ANY SPECIAL, CONSEQUENTIAL, INCIDENTAL, OR INDIRECT DAMAGES, INCLUDING, AMONG OTHERS, DAMAGES FOR LOSS OF BUSINESS PROFITS, BUSINESS INTERRUPTION, OR LOSS OF DATA OR DOCUMENTATION, IN CONNECTION WITH THE USE OF THIS PRODUCT, EVEN IF HIKVISION HAS BEEN ADVISED OF THE POSSIBILITY OF SUCH DAMAGES.

REGARDING TO THE PRODUCT WITH INTERNET ACCESS, THE USE OF PRODUCT SHALL BE WHOLLY AT YOUR OWN RISKS. HIKVISION SHALL NOT TAKE ANY RESPONSIBILITIES FOR ABNORMAL OPERATION, PRIVACY LEAKAGE OR OTHER DAMAGES RESULTING FROM CYBER ATTACK, HACKER ATTACK, VIRUS INSPECTION, OR OTHER INTERNET SECURITY RISKS; HOWEVER, HIKVISION WILL PROVIDE TIMELY TECHNICAL SUPPORT IF REQUIRED.

SURVEILLANCE LAWS VARY BY JURISDICTION. PLEASE CHECK ALL RELEVANT LAWS IN YOUR JURISDICTION BEFORE USING THIS PRODUCT IN ORDER TO ENSURE THAT YOUR USE CONFORMS THE APPLICABLE LAW. HIKVISION SHALL NOT BE LIABLE IN THE EVENT THAT THIS PRODUCT IS USED WITH ILLEGITIMATE PURPOSES.

IN THE EVENT OF ANY CONFLICTS BETWEEN THIS MANUAL AND THE APPLICABLE LAW, THE LATER PREVAILS.

Regulatory Information

FCC Information

FCC compliance: This equipment has been tested and found to comply with the limits for a Class A digital device, pursuant to part 15 of the FCC Rules. These limits are designed to provide reasonable protection against harmful interference when the equipment is operated in a commercial environment. This equipment generates, uses, and can radiate radio frequency energy and, if not installed and used in accordance with the instruction manual, may cause harmful interference to radio communications. Operation of this equipment in a residential area is likely to cause harmful interference in which case the user will be required to correct the interference at his own expense.

FCC Conditions

This device complies with part 15 of the FCC Rules. Operation is subject to the following two conditions:

1. This device may not cause harmful interference.
2. This device must accept any interference received, including interference that may cause undesired operation.

EU Conformity Statement



This product and - if applicable - the supplied accessories too are marked with "CE" and comply therefore with the applicable harmonized European standards listed under the EMC Directive

2004/108/EC, the RoHS Directive 2011/65/EU.



2012/19/EU (WEEE directive): Products marked with this symbol cannot be disposed of as unsorted municipal waste in the European Union. For proper recycling, return this product to your local supplier upon the purchase of equivalent new equipment, or dispose of it at designated

collection points. For more information see: www.recyclethis.info



2006/66/EC (battery directive): This product contains a battery that cannot be disposed of as unsorted municipal waste in the European Union. See the product documentation for specific battery information. The battery is marked with this symbol, which may include lettering to

indicate cadmium (Cd), lead (Pb), or mercury (Hg). For proper recycling, return the battery to your supplier or to a designated collection point. For more information see: www.recyclethis.info

Industry Canada ICES-003 Compliance



This device meets the CAN ICES-3 (A)/NMB-3(A) standards requirements.

Safety Instruction

These instructions are intended to ensure that user can use the product correctly to avoid danger or property loss. The precaution measure is divided into “Warnings” and “Cautions”

Warnings: Serious injury or death may occur if any of the warnings are neglected.

Cautions: Injury or equipment damage may occur if any of the cautions are neglected.

	
Warnings Follow these safeguards to prevent serious injury or death.	Cautions Follow these precautions to prevent potential injury or material damage.



Warnings

- Proper configuration of all passwords and other security settings is the responsibility of the installer and/or end-user.
- In the use of the product, you must be in strict compliance with the electrical safety regulations of the nation and region. Please refer to technical specifications for detailed information.
- Input voltage should meet both the SELV (Safety Extra Low Voltage) and the Limited Power Source with 100~240 VAC or 12 VDC according to the IEC60950-1 standard. Please refer to technical specifications for detailed information.
- Do not connect several devices to one power adapter as adapter overload may cause over-heating or a fire hazard.
- Please make sure that the plug is firmly connected to the power socket.
- If smoke, odor or noise rise from the device, turn off the power at once and unplug the power cable, and then please contact the service center.

Preventive and Cautionary Tips

Before connecting and operating your device, please be advised of the following tips:

- Ensure unit is installed in a well-ventilated, dust-free environment.
- Unit is designed for indoor use only.
- Keep all liquids away from the device.
- Ensure environmental conditions meet factory specifications.
- Ensure unit is properly secured to a rack or shelf. Major shocks or jolts to the unit as a result of dropping it may cause damage to the sensitive electronics within the unit.
- Use the device in conjunction with an UPS if possible.
- Power down the unit before connecting and disconnecting accessories and peripherals.
- A factory recommended HDD should be used for this device.
- Improper use or replacement of the battery may result in hazard of explosion. Replace with the same or equivalent type only. Dispose of used batteries according to the instructions provided by the battery manufacturer.



Applicable Models

This manual is applicable to the models listed in the following table.

Series	Model	Type
DS-7100HGHI-SH	DS-7104HGHI-SH DS-7108HGHI-SH	Network Turbo HD DVR
DS-7100HQHI-SH	DS-7104HQHI-SH	Network Turbo HD DVR
DS-7100HGHI-E1	DS-7104HGHI-E1 DS-7108HGHI-E1 DS-7116HGHI-E1	Network Turbo HD DVR
DS-7200HGHI-SH	DS-7204HGHI-SH DS-7208HGHI-SH DS-7216HGHI-SH	Network Turbo HD DVR
DS-7200HQHI-SH	DS-7204HQHI-SH DS-7208HQHI-SH DS-7216HQHI-SH	Network Turbo HD DVR
DS-7200HQHI-E1/E2	DS-7204HQHI-E1 DS-7208HQHI-E1 DS-7216HQHI-E2	Network Turbo HD DVR
DS-7200HGHI-E1	DS-7204HGHI-E1 DS-7208HGHI-E1 DS-7216HGHI-E1	Network Turbo HD DVR
DS-7200HGHI-E2	DS-7208HGHI-E2 DS-7216HGHI-E2	Network Turbo HD DVR
DS-7300HGHI-SH	DS-7304HGHI-SH DS-7308HGHI-SH DS-7316HGHI-SH DS-7324HGHI-SH DS-7332HGHI-SH	Network Turbo HD DVR
DS-7300HQHI-SH	DS-7304HQHI-SH DS-7308HQHI-SH DS-7316HQHI-SH	Network Turbo HD DVR
DS-8100HGHI-SH	DS-8104HGHI-SH DS-8108HGHI-SH DS-8116HGHI-SH DS-8124HGHI-SH DS-8132HGHI-SH	Network Turbo HD DVR
DS-8100HQHI-SH	DS-8104HQHI-SH DS-8108HQHI-SH DS-8116HQHI-SH	Network Turbo HD DVR
DS-9000HQHI-SH	DS-9004HQHI-SH DS-9008HQHI-SH DS-9016HQHI-SH	Network Turbo HD DVR
DS-7100HGHI-F1	DS-7104HGHI-F1 DS-7108HGHI-F1 DS-7116HGHI-F1	Network Turbo HD DVR
DS-7200HGHI-F1	DS-7204HGHI-F1 DS-7208HGHI-F1 DS-7216HGHI-F1	Network Turbo HD DVR
DS-7200HGHI-F2	DS-7208HGHI-F2 DS-7216HGHI-F2	Network Turbo HD DVR

Symbol Conventions

The symbols that may be found in this document are defined as follows.

Symbol	Description
	Indicates a potentially hazardous situation, which if not avoided, could result in equipment damage, data loss, performance degradation, or unexpected results.
	Provides additional information to emphasize or supplement important points of the main text.

Product Key Features

General

- Connectable to HD-TVI and analog cameras;
- DS-7100/7200-F series DVR connectable to AHD cameras.
- Connectable to the Coaxitron cameras with long transmission distance;
- Connectable to IP cameras;



The IP camera connection is not supported by DS-7100.

- Each channel supports dual-stream. Main stream supports up to 1080P resolution and sub-stream supports up to WD1 resolution;



The DS-7100-E1/F1, DS-7200-E1/E2 and DS-7200-F1/F2 support up to 720P resolution, and DS-7200HQHI-E1/E2 supports up to 1080p (lite) (960×1080) resolution.

- Independent configuration for each channel, including resolution, frame rate, bit rate, image quality, etc.
- Encoding for both video stream and video & audio stream; audio and video synchronization during composite stream encoding;
- Watermark technology.

Local Monitoring

- HDMI/VGA output at up to 1920×1080 resolution;
- 1/4/6/8/9/16/25/36 screen live view is supported, and the display sequence of screens is adjustable;
- Live view screen can be switched in group and manual switch and automatic cycle live view are also provided, the interval of automatic cycle can be adjusted;
- Quick setting menu is provided for live view;
- The selected live view channel can be shielded;
- Motion detection, video-tampering detection, video exception alarm, video loss alarm and VCA alarm functions;
- Privacy mask;
- Several PTZ protocols supported; PTZ preset, patrol and pattern;
- Zooming in/out by clicking the mouse and PTZ tracing by dragging mouse.

HDD Management

- For DS-7100HGHI-SH/E1/F1, DS-7104HQHI-SH, DS-7200HGHI-E1/F1 and DS-7200HQHI-E1 series, 1 SATA hard disk can be connected;
For DS-7200HGHI&HQHI-SH, DS-7200HGHI-E2/F2, and DS-7200HQHI-E2 series, up to 2 SATA hard disks can be connected;
For DS-7300HGHI&HQHI-SH series, 4 SATA hard disks and 1 eSATA disk can be connected;
For DS-8100/9000-SH series, 8 SATA hard disks and 1 eSATA disk can be connected.
- Each disk with a maximum of 6TB storage capacity;
- 8 network disks (NAS /IP SAN disks) can be connected;
- Supports eSATA disks for recording or backup;
- S.M.A.R.T. and bad sector detection;
- HDD sleeping function;
- HDD property: redundancy, read-only, read/write (R/W);

- HDD group management;
- HDD quota management; different capacity can be assigned to different channels.
- For DS-9000-SH series, hot-swappable HDD supporting RAID0, RAID1, RAID5 and RAID10 storage scheme, and can be enabled and disabled on your demand. And 16 arrays can be configured.

Recording and Playback

- Holiday recording schedule configuration;
- Cycle and non-cycle recording modes;
- Normal and event video encoding parameters;
- Multiple recording types: manual, continuous, alarm, motion, motion | alarm, motion & alarm and VCA;



DS-7100 does not support VCA triggered recording type.

- 8 recording time periods with separated recording types;
- Pre-record and post-record for motion detection triggered recording, and pre-record time for schedule and manual recording;
- Searching record files by events (alarm input/motion detection);
- Customization of tags, searching and playing back by tags;
- Locking and unlocking of record files;
- Local redundant recording;
- Searching and playing back record files by camera number, recording type, start time, end time, etc.;
- Smart playback to go through less effective information;
- Zooming in for any area when playback;
- Multi-channel reverse playback;
- Supports pause, fast forward, slow forward, skip forward, and skip backward when playback, locating by dragging the mouse on the progress bar;
- 4/8/16/24/32-ch synchronous playback.

Backup

- Export data by a USB, SATA or eSATA device;
- Export video clips when playback;
- Management and maintenance of backup devices.

Alarm and Exception

- Configurable arming time of alarm input/output;
- Alarm for video loss, motion detection, video tampering, abnormal signal, video input/recording resolution mismatch, illegal login, network disconnected, IP conflict, record exception, HDD error, and HDD full, etc.;
- Alarm triggers full screen monitoring, audio alarm, notifying surveillance center, sending email and alarm output;
- VCA detection alarm (line crossing detection and intrusion detection) is supported;



DS-7100 does not support VCA alarm.

- Support coaxial alarm;
- Automatic restore when system is abnormal.

Other Local Functions

- Manual and automatic video quality diagnostics;
- Users can operate by mouse and remote control;

- Three-level user management; admin user can create many operating account and define their operating permission, which includes the permission to access any channel;
- Completeness of operation, alarm, exceptions and log writing and searching;
- Manually triggering and clearing alarms;
- Importing and exporting of configuration file of devices;
- Getting cameras type information automatically.

Network Functions

- 1 self-adaptive 10M/100M network interface for DS-7100, DS-7204/7208HGHI-SH, DS-7200HGHI-E1/E2, DS-7200HGHI-F1/F2 and DS-7204/7208HQHI-E1; 2 self-adaptive 10M/100M/1000M network interfaces for DS-8100HQHI&HGHI-SH and DS-9000HQHI-SH series, with three working modes configurable: multi-address, load balance, network fault tolerance; and 1 self-adaptive 10M/100M/1000M network interface for other models;
- IPv6 is supported;
- TCP/IP protocol, PPPoE, DHCP, DNS, DDNS, NTP, SADP, SMTP, SNMP, NFS, iSCSI, UPnP™ and HTTPS are supported;
- Extranet access by HiDDNS;
- Support access by EZVIZ Cloud P2P;
- TCP, UDP and RTP for unicast;
- Auto/Manual port mapping by UPnP™;
- Remote search, playback, download, locking and unlocking the record files, and downloading files broken transfer resume;
- Remote parameters setup; remote import/export of device parameters;
- Remote viewing of the device status, system logs and alarm status;
- Remote keyboard operation;
- Remote locking and unlocking of control panel and mouse;
- Remote HDD formatting and program upgrading;
- Remote system restart and shutdown;
- Support upgrading via remote FTP server;
- RS-232, RS-485 transparent channel transmission;
- Alarm and exception information can be sent to the remote host;
- Remotely start/stop recording;
- Remotely start/stop alarm output;
- Remote PTZ control;
- Remote JPEG capture;
- Two-way audio and voice broadcasting;
- Embedded WEB server.

Development Scalability

- SDK for Windows and Linux system;
- Source code of application software for demo;
- Development support and training for application system.

Table of Contents

Product Key Features	7
Chapter 1 Introduction.....	14
1.1 Front Panels.....	15
1.2 IR Remote Control Operations	24
1.3 USB Mouse Operation	27
1.4 Input Method Description.....	28
1.5 Rear Panel	29
Chapter 2 Getting Started	33
2.1 Starting Up and Shutting Down the DVR.....	34
2.2 Activating the Device	36
2.3 Basic Configuration in Startup Wizard	37
2.3.1 Configuring the Signal Input Channel	37
2.3.2 Using the Wizard for Basic Configuration	37
2.4 Login and Logout	42
2.4.3 User Login	42
2.4.4 User Logout	42
2.5 Adding and Connecting the IP Cameras	44
2.5.5 Activating the IP Camera	44
2.5.6 Adding the Online IP Cameras.....	45
2.5.7 Editing the Connected IP Cameras.....	49
2.6 Configuring the Signal Input Channel	51
Chapter 3 Live View	52
3.1 Introduction of Live View	53
3.2 Operations in Live View Mode.....	54
3.2.1 Front Panel Operation	55
3.2.2 Using the Mouse in Live View.....	55
3.2.3 Main/Aux Output Switching.....	56
3.2.4 Quick Setting Toolbar in Live View Mode	57
3.3 Channel-zero Encoding	60
3.4 Adjusting Live View Settings	61
3.5 Manual Video Quality Diagnostics	63
3.6 User Logout.....	64
Chapter 4 PTZ Controls	65
4.1 Configuring PTZ Settings.....	66
4.2 Setting PTZ Presets, Patrols & Patterns.....	68
4.2.1 Customizing Presets.....	68
4.2.2 Calling Presets	68
4.2.3 Customizing Patrols	69
4.2.4 Calling Patrols	70
4.2.5 Customizing Patterns	71
4.2.6 Calling Patterns.....	72

4.2.7	Customizing Linear Scan Limit	72
4.2.8	Calling Linear Scan	73
4.2.9	One-touch Park	74
4.3	PTZ Control Panel.....	75
Chapter 5	Recording Settings	76
5.1	Configuring Recording Parameters	77
5.2	Configuring Record Schedule	80
5.3	Configuring Motion Detection Record	83
5.4	Configuring Alarm Triggered Record.....	85
5.5	Configuring VCA Triggered Record.....	87
5.6	Configuring Manual Record.....	89
5.7	Configuring Holiday Record	90
5.8	Configuring Redundant Recording	92
5.9	Configuring HDD Group for Recording.....	94
5.10	Files Protection.....	95
Chapter 6	Playback.....	97
6.1	Playing Back Record Files	98
6.1.1	Instant Playback.....	98
6.1.2	Playing Back by Normal Search	98
6.1.3	Playing Back by Event Search	101
6.1.4	Playing Back by Tag	103
6.1.5	Playing Back by Smart Search.....	105
6.1.6	Playing Back by System Logs	107
6.1.7	Playing Back External File	109
6.2	Auxiliary Functions of Playback	110
6.2.8	Playing Back Frame by Frame.....	110
6.2.9	Digital Zoom.....	110
6.2.10	Reverse Playback of Multi-channel	110
Chapter 7	Backup	112
7.1	Backing up Record Files	113
7.1.1	Backing up by Normal Video Search.....	113
7.1.2	Backing up by Event Search	116
7.1.3	Backing up Video Clips	119
7.2	Managing Backup Devices.....	122
Chapter 8	Alarm Settings.....	124
8.1	Setting Motion Detection.....	125
8.2	Setting Sensor Alarms	127
8.3	Detecting Video Loss.....	130
8.4	Detecting Video Tampering	132
8.5	Detecting VCA Alarm	134
8.6	Setting All-day Video Quality Diagnostics.....	138
8.7	Handling Exceptions	139
8.8	Setting Alarm Response Actions	141
8.9	Triggering or Clearing Alarm Output Manually	143

Chapter 9 Network Settings	144
9.1 Configuring General Settings	145
9.2 Configuring Advanced Settings	147
9.2.1 Configuring Extranet Access	147
9.2.2 Configuring PPPoE Settings	152
9.2.3 Configuring NTP Server	152
9.2.4 Configuring SNMP	153
9.2.5 Configuring NAT	154
9.2.6 Configuring More Settings.....	156
9.2.7 Configuring HTTPS Port	157
9.2.8 Configuring Email	158
9.3 Checking Network Traffic	159
9.4 Configuring Network Detection	161
9.4.1 Testing Network Delay and Packet Loss.....	161
9.4.2 Exporting Network Packet	161
9.4.3 Checking Network Status.....	163
9.4.4 Checking Network Statistics	163
Chapter 10 HDD Management.....	165
10.1 Initializing HDDs	166
10.2 Managing Network HDD	168
10.3 Managing eSATA	170
10.4 Managing HDD Group	171
10.4.1 Setting HDD Groups.....	171
10.4.2 Setting HDD Property	172
10.5 Configuring Quota Mode.....	174
10.6 Checking HDD Status	175
10.7 Checking S.M.A.R.T Information	176
10.8 Detecting Bad Sector.....	177
10.9 Configuring HDD Error Alarms	178
Chapter 11 Camera Settings	179
11.1 Configuring OSD Settings.....	180
11.2 Configuring Privacy Mask.....	181
11.3 Configuring Video Parameters	182
Chapter 12 DVR Management and Maintenance	183
12.1 Viewing System Information.....	184
12.2 Searching and Exporting Log Files	184
12.3 Importing/Exporting IP Camera Info.....	187
12.4 Importing/Exporting Configuration Files	188
12.5 Upgrading System	189
12.5.1 Upgrading by Local Backup Device	189
12.5.2 Upgrading by FTP	189
12.6 Restoring Default Settings.....	190
Chapter 13 Others.....	191
13.1 Configuring RS-232 Serial Port.....	192

13.2	Configuring General Settings	193
13.3	Configuring DST Settings	194
13.4	Configuring More Settings	195
13.5	Managing User Accounts.....	196
13.5.1	Adding a User	196
13.5.2	Deleting a User	198
13.5.3	Editing a User	199
Appendix	201
Specifications	202
DS-7104HGHI-SH	202
DS-7104HQHI-SH	203
DS-7100HGHI-E1	204
DS-7100HGHI-F1	205
DS-7200HGHI-SH	206
DS-7200HQHI-SH	207
DS-7200HGHI-E1	208
DS-7200HGHI-E2	209
DS-7200HQHI-E1/E2	210
DS-7200HGHI-F1	211
DS-7200HGHI-F2	212
DS-7300HGHI-SH	213
DS-7324/7332HGHI-SH	215
DS-7300HQHI-SH	216
DS-8100HGHI-SH	217
DS-8124/8132HGHI-SH	218
DS-8100HQHI-SH	219
DS-9000HQHI-SH	220
Glossary	221
Troubleshooting	222
List of Compatible Hikvision IP Cameras	225
List of Compatible Third-party IP Cameras	226

Chapter 1 Introduction

1.1 Front Panels

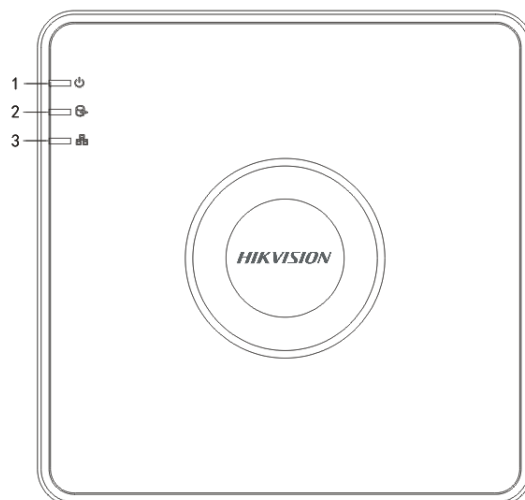

Figure 1. 1 Front Panel of DS-7100

Table 1. 1 Description of Front Panel

No.	Icon	Description
1		Turns red when DVR is powered up.
2		Turns red when data is being read from or written to HDD.
3		Flickers blue when network connection is functioning properly.



Figure 1. 2 Front Panel of DS-7204/7208HGHI-SH



Figure 1. 3 Front Panel of DS-7216HGHI-SH



Please refer to Figure 1.2 and Figure 1.3 for the front panel of DS-7200HGHI-E1/E2 and DS-7200HQHI-E1/E2.

Table 1. 2 Description of Front Panel

No.	Name	Function Description
1	POWER	Turns yellow when the power switch on the rear panel is turned on.
	STATUS	Flickers red when data is being read from or written to HDD.

No.	Name	Function Description
	Tx/Rx	Flickers yellow when network connection is functioning properly.
2	IR Receiver	Receiver for IR remote
3	USB Interfaces	Universal Serial Bus (USB) ports for additional devices such as USB mouse and USB Hard Disk Drive (HDD).

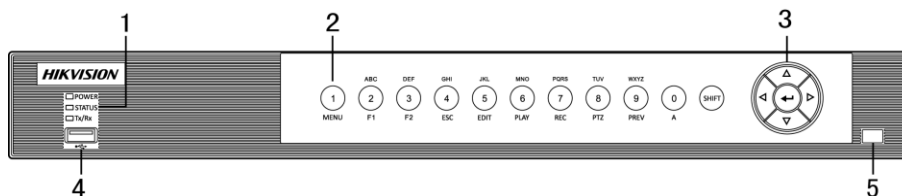

Figure 1. 4 Front Panel of DS-7200HQHI-SH

Table 1. 3 Description of Front Panel

No.	Name	Function Description	
1	POWER	Turns yellow when the devices running.	
	STATUS	Flickers red when data is being read from or written to HDD, and turns yellow when the SHIFT function is realized.	
	Tx/Rx	Flickers yellow when network connection is functioning properly.	
2	Composite Keys	SHIFT	Switches between the numeric or letter input and functions of the composite keys.
		1/MENU	Enters numeral “1”; Accesses the main menu interface.
		2/ABC/F1	Enters numeral “2”;
			Enters letters “ABC”;
			Uses the F1 button to select all items in a list field; Turns on/off PTZ light in PTZ Control mode, and use it to zoom out the image;
		3/DEF/F2	Switches between main and spot video output in live view or playback mode.
			Enters numeral “3”;
			Enters letters “DEF”;
		4/GHI/ESC	Uses the F2 button to change the tab pages;
			Zooms in the image in PTZ control mode.
			Enters numeral “4”;
		5/JKL/EDIT	Enters letters “GHI”;
Exits and back to the previous menu.			
Enters numeral “5”;			
Enters letters “JKL”;			
6/MNO/PLAY	Deletes characters before cursor;		
	Checks the checkbox and select the ON/OFF switch;		
	Starts/stops record clipping in playback.		
7/PQRS/REC	Enters numeral “6”;		
	Enters letters “MNO”;		
		Accesses to playback interface in Playback mode.	
		Enters numeral “7”;	

No.	Name	Function Description
		Enters letters “PQRS”;
		Accesses to manual record interface; Manually enables/disables record.
		8/TUV/PTZ
		Enters numeral “8”;
		Enters letters “TUV”;
		Accesses PTZ control interface.
		9/WXYZ/PREV
		Enters numeral “9”;
		Enters letters “WXYZ”; Multi-channel display in live view.
		0/A
Enters numeral “0”; Shifts the input methods in the editing text field. (Upper and lowercase, alphabet, symbols or numeric input).		
3	DIRECTION	Navigates between different fields and items in menus.
		Uses the Up and Down buttons to speed up and slow down the playing of video files in Playback mode. The Left and Right button will select the next and previous record files.
		Cycles through channels in Live View mode.
		Controls the movement of the PTZ camera in PTZ control mode.
	ENTER	Confirms selection in any of the menu modes.
		Checks the checkbox.
		Plays or pauses the playing of video files in Playback mode.
		Advances the video by a single frame in single-frame Playback mode.
		Stops/starts auto switch in Auto-switch mode.
4	USB Interface	Universal Serial Bus (USB) ports for additional devices such as USB mouse and USB Hard Disk Drive (HDD).
5	IR Receiver	Receiver for IR remote control.

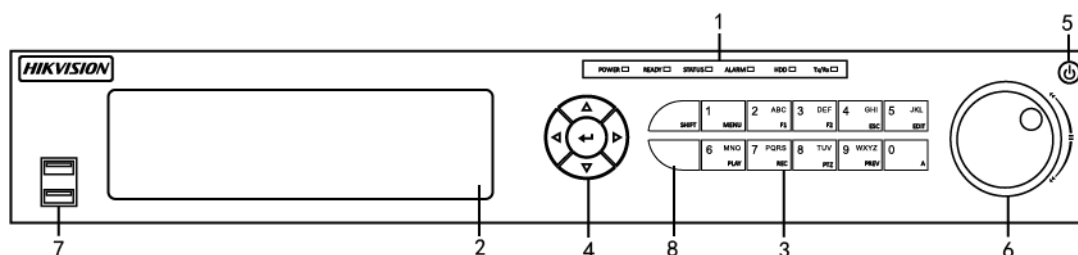

Figure 1. 5 Front Panel of DS-7300HGHI-SH and DS-7300HQHI-SH

Table 1. 4 Description of Front Panel

No.	Name	Function Description
1	POWER	Turns green when DVR is powered up.
	READY	Turns green, indicating that the DVR is functioning properly.
	STATUS	Turns blue when device is controlled by an IR remote.
		Turns red when controlled by a keyboard and purple when IR remote

No.	Name	Function Description	
		and keyboard is used at the same time.	
	ALARM	Turns red when a sensor alarm is detected.	
	HDD	Flickers in red when data is being read from or written to HDD.	
	Tx/Rx	Flickers in green when network connection is functioning properly.	
2	DVD-R/W	Slot for DVD-R/W.	
3	Composite Keys	SHIFT	Switches between the numeric or letter input and functions of the composite keys. (Input letter or numbers when the light is out; Realize functions when the light is red.)
		1/MENU	Enters numeral "1"; Accesses the main menu interface.
		2/ABC/F1	Enters numeral "2";
			Enters letters "ABC";
			The F1 button when used in a list field will select all items in the list;
			Turns on/off PTZ light in PTZ Control mode, and use it to zoom out the image;
		3/DEF/F2	Switches between main and spot video output in live view or playback mode.
			Enters numeral "3";
			Enters letters "DEF";
			Uses the F2 button is used to change the tab pages;
		4/GHI/ESC	Zooms in the image in PTZ control mode.
			Enters numeral "4";
			Enters letters "GHI";
			Exits and back to the previous menu.
		5/JKL/EDIT	Enters numeral "5";
			Enters letters "JKL";
			Deletes characters before cursor;
			Check the checkbox and select the ON/OFF switch;
		6/MNO/PLAY	Starts/stops record clipping in playback.
			Enters numeral "6";
			Enters letters "MNO";
		7/PQRS/REC	Accesses to playback interface in Playback mode.
			Enters numeral "7";
			Enters letters "PQRS";
		8/TUV/PTZ	Accesses to manual record interface;
			Manually enables/disables record.
			Enters numeral "8";
9/WXYZ/PREV	Enters letters "TUV";		
	Accesses PTZ control interface.		
	Enters numeral "9";		
0/A	Enters letters "WXYZ";		
	Multi-channel display in live view.		
	Enters numeral "0";		
4	DIRECTION	Shifts the input methods in the editing text field. (Upper and lowercase, alphabet, symbols or numeric input).	
		Navigates between different fields and items in menus.	

No.	Name	Function Description
		Uses the Up and Down buttons to speed up and slow down the playing of video files in Playback mode. The Left and Right button will select the next and previous record files.
		Cycles through channels in Live View mode.
		Controls the movement of the PTZ camera in PTZ control mode.
		Confirms selection in any of the menu modes.
	ENTER	Checks the checkbox.
		Plays or pauses the playing of video files in Playback mode.
		Advances the video by a single frame in single-frame Playback mode.
		Stops/starts auto switch in Auto-switch mode.
5	POWER	Power on/off switch.
6	JOG SHUTTLE Control	Moves the active selection up and down in a menu.
		Cycles through different channels in live view mode.
		Jumps 30s forward/backward in video files in the playback mode.
		Controls the movement of the PTZ camera in PTZ control mode.
		Moves the active selection up and down in a menu.
7	USB Interface	Universal Serial Bus (USB) ports for additional devices such as USB mouse and USB Hard Disk Drive (HDD).
8	IR Receiver	Receiver for IR remote control.

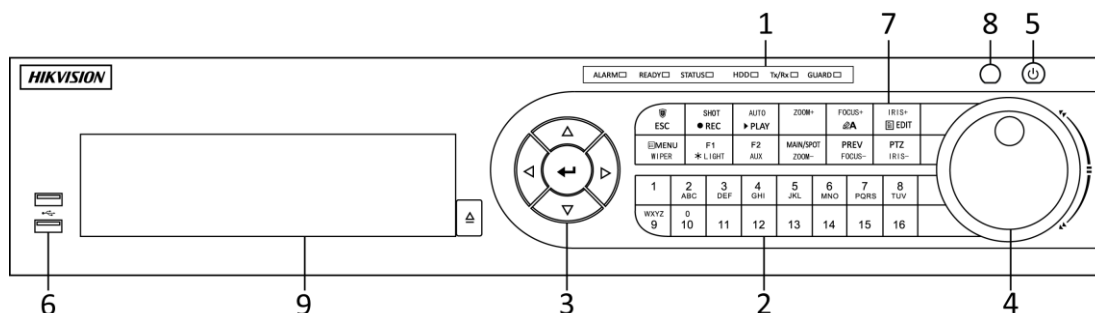

Figure 1. 6 Front Panel of DS-8100-SH

Table 1. 5 Description of Front Panel

No.	Name	Function Description	
1	Status Indicators	ALARM	Turns red when a sensor alarm is detected.
		READY	Turns green, indicating that the DVR is functioning properly.
		STATUS	Turns blue when device is controlled by an IR remote.
			Turns red when controlled by a keyboard and purple when IR remote and keyboard is used at the same time.
		HDD	Flickers in red when data is being read from or written to HDD.
		Tx/Rx	Flickers in green when network connection is functioning properly.
		GUARD	Turns blue when the device is in armed status; at this time, an alarm is enabled when an event is detected.

No.	Name		Function Description
			Turns off when the device is unarmed. The arm/disarm status can be changed by pressing and holding on the ESC button for more than 3 seconds in live view mode.
2	Alphanumeric Buttons		Switches to the corresponding channel in live view or PTZ control mode.
			Inputs numbers and characters in edit mode.
			Switches between different channels in playback mode.
			Turns blue when the corresponding channel is recording; turns red when the channel is in network transmission status; turns pink when the channel is recording and transmitting.
3	Control Buttons	DIRECTION	Navigates between different fields and items in menus.
			Uses the Up and Down buttons to speed up and slow down the playing of video files in Playback mode.
			The Left and Right button will select the next and previous record files.
			Cycles through channels in Live View mode.
			Controls the movement of the PTZ camera in PTZ control mode.
	ENTER	Confirms selection in any of the menu modes.	
		Checks the checkbox.	
		Plays or pauses the playing of video files in Playback mode.	
		Advances the video by a single frame in single-frame Playback mode.	
		Stops/starts auto switch in Auto-switch mode.	
4	JOG SHUTTLE Control		Moves the active selection up and down in a menu.
			Cycles through different channels in live view mode.
			Jumps 30s forward/backward in video files in the playback mode.
			Controls the movement of the PTZ camera in PTZ control mode.
5	POWER		Power on/off switch.
6	USB Interfaces		Universal Serial Bus (USB) ports for additional devices such as USB mouse and USB Hard Disk Drive (HDD).
7	Composite Keys	ESC	Returns to the previous menu.
			Presses for arming/disarming the device in live view mode.
		REC/SHOT	Enters the Manual Record settings menu.
			Presses this button followed by a numeric button to call a PTZ preset in PTZ control settings.
			Turns audio on/off in the playback mode.
		PLAY/AUTO	Enters the playback mode.
			Automatically scans in the PTZ control menu.
		ZOOM+	Zooms in the PTZ camera in the PTZ control setting.
		A/FOCUS+	Adjusts focus in the PTZ Control menu.
			Switches between input methods (upper and lower case alphabet, symbols and numeric input).
		EDIT/IRIS+	Edits text fields. When editing text fields, it also deletes the character in front of the cursor.
			Checks the checkbox in the checkbox fields.
Adjusts the iris of the camera in PTZ control mode.			

No.	Name	Function Description	
		Generates video clips for backup in playback mode.	
		Enters/exits the folder of USB device and eSATA HDD.	
		MAIN/SPOT/ZOOM-	Switches between main and spot output.
			Zooms out the image in PTZ control mode.
		F1/ LIGHT	Selects all items on the list when used in a list field.
			Turns on/off PTZ light (if applicable) in PTZ control mode.
			Switches between play and reverse play in playback mode.
		F2/ AUX	Cycles through tab pages.
			Switches between channels in synchronous playback mode.
		MENU/WIPER	Returns to the Main menu (after successful login).
			Presses and holds the button for five seconds to turn off audible key beep.
			Starts wiper (if applicable) in PTZ control mode.
			Shows/hides the control interface in playback mode.
		PREV/FOCUS-	Switches between single screen and multi-screen mode.
Adjusts the focus in conjunction with the A/FOCUS+ button in PTZ control mode.			
PTZ/IRIS-	Enters the PTZ Control mode.		
	Adjusts the iris of the PTZ camera in PTZ control mode.		
8	IR Receiver	Receiver for IR remote control.	
9	DVD-R/W	Slot for DVD-R/W.	

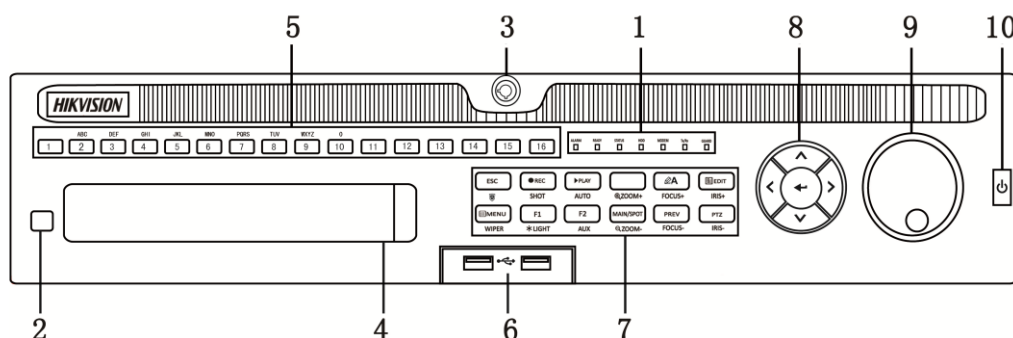

Figure 1. 7 Front Panel of DS-9000HQHI-SH

Table 1. 6 Description of Control Panel Buttons

No.	Name	Function Description
1	ALARM	Turns red when a sensor alarm is detected.
	READY	Turns green, indicating that the DVR is functioning properly.
	STATUS	Turns blue when device is controlled by an IR remote.
		Turns red when controlled by a keyboard and purple when IR remote and keyboard is used at the same time.
	HDD	Flickers in red when data is being read from or written to HDD.
	MODEM	Reserved for future usage.
	TX/RX	Flickers in green when network connection is functioning properly.
GUARD	Turns blue when the device is in armed status; at this time, an alarm is enabled when an event is detected.	

		Turns off when the device is unarmed. The arm/disarm status can be changed by pressing and holding on the ESC button for more than 3 seconds in live view mode.
2	IR Receiver	Receiver for IR remote
3	Front Panel Lock	Lock or unlock the panel by the key.
4	DVD-R/W	Slot for DVD-R/W.
5	Alphanumeric Buttons	Switches to the corresponding channel in live view or PTZ control mode.
		Inputs numbers and characters in edit mode.
		Switches between different channels in playback mode.
		Turns blue when the corresponding channel is recording; turns red when the channel is in network transmission status; turns pink when the channel is recording and transmitting.
6	USB Interfaces	Universal Serial Bus (USB) ports for additional devices such as USB mouse and USB Hard Disk Drive (HDD).
7	ESC	Returns to the previous menu.
		Presses for arming/disarming the device in live view mode.
	REC/SHOT	Enters the Manual Record settings menu.
		Presses this button followed by a numeric button to call a PTZ preset in PTZ control settings.
		Turns audio on/off in the playback mode.
	PLAY/AUTO	Enters the playback mode.
		Automatically scans in the PTZ control menu.
	ZOOM+	Zooms in the PTZ camera in the PTZ control setting.
	A/FOCUS+	Adjusts focus in the PTZ Control menu.
		Switches between input methods (upper and lower case alphabet, symbols and numeric input).
	EDIT/IRIS+	Edits text fields. When editing text fields, it also deletes the character in front of the cursor.
		Checks the checkbox in the checkbox fields.
		Adjusts the iris of the camera in PTZ control mode.
		Generates video clips for backup in playback mode.
		Enters/exits the folder of USB device and eSATA HDD.
	MAIN/SPOT/ZOOM-	Switches between main and spot output.
		Zooms out the image in PTZ control mode.
	F1/ LIGHT	Selects all items on the list when used in a list field.
		Turns on/off PTZ light (if applicable) in PTZ control mode.
		Switches between play and reverse play in playback mode.
	F2/ AUX	Cycles through tab pages.
		Switches between channels in synchronous playback mode.
	MENU/WIPER	Returns to the Main menu (after successful login).
Presses and holds the button for five seconds to turn off audible key beep.		
Starts wiper (if applicable) in PTZ control mode.		
Shows/hides the control interface in playback mode.		
PREV/FOCUS-	Switches between single screen and multi-screen mode.	

		Adjusts the focus in conjunction with the A/FOCUS+ button in PTZ control mode.
	PTZ/IRIS-	Enters the PTZ Control mode. Adjusts the iris of the PTZ camera in PTZ control mode.
8	DIRECTION	Navigates between different fields and items in menus.
		Uses the Up and Down buttons to speed up and slow down the playing of video files in Playback mode.
		The Left and Right button will select the next and previous record files.
		Cycles through channels in Live View mode.
		Controls the movement of the PTZ camera in PTZ control mode.
	ENTER	Confirms selection in any of the menu modes.
		Checks the checkbox.
		Plays or pauses the playing of video files in Playback mode.
		Advances the video by a single frame in single-frame Playback mode.
		Stops/starts auto switch in Auto-switch mode.
9	JOG SHUTTLE Control	Moves the active selection up and down in a menu.
		Cycles through different channels in live view mode.
		Jumps 30s forward/backward in video files in the playback mode.
		Controls the movement of the PTZ camera in PTZ control mode.
10	POWER ON/OFF	Power on/off switch.

1.2 IR Remote Control Operations

The DVR may also be controlled with the included IR remote control, shown in Figure 1. 8.



Batteries (2×AAA) must be installed before operation.

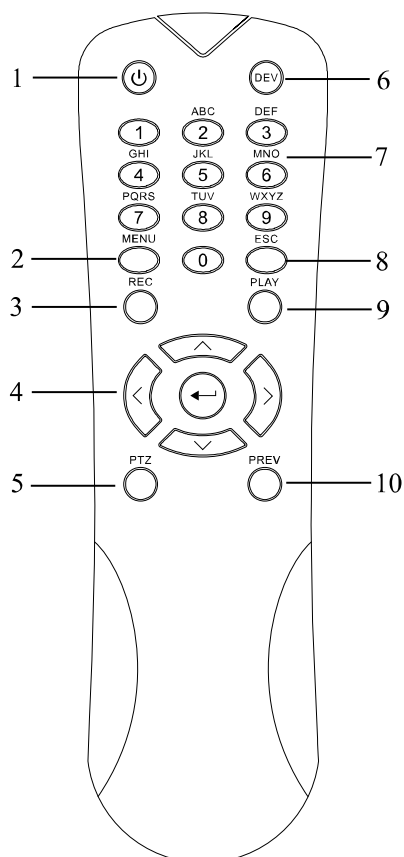

Figure 1. 8 Remote Control

The keys on the remote control closely resemble the ones found on the front panel. Refer to Table 1. 7, they include:

Table 1. 7 Description of the IR Remote Control Buttons

No.	Name	Description
1	POWER	Power on/off the device.
		Power on/off the device by pressing and holding the button for 3 seconds.
2	MENU Button	Press the button to return to the main menu (after successful login).
		Press and hold the button for 5 seconds will turn off audible key beep.
		In PTZ Control mode, the MENU button will start wiper (if applicable).
		In Playback mode, it is used to show/hide the control interface.
3	REC Button	Enter the Manual Record setting menu.
		In PTZ control settings, press the button and then you can call a PTZ preset by pressing Numeric button.

No.	Name	Description
		It is also used to turn audio on/off in the Playback mode.
4	DIRECTION Button	Navigate between different fields and items in menus.
		In the Playback mode, the Up and Down button is used to speed up and slow down recorded video. The Left and Right button will select the next and previous record files.
		In Live View mode, these buttons can be used to cycle through channels.
		In PTZ control mode, it can control the movement of the PTZ camera.
	ENTER Button	Confirm selection in any of the menu modes.
		It can also be used to <i>tick</i> checkbox fields.
		In Playback mode, it can be used to play or pause the video.
		In single-frame Playback mode, pressing the button will advance the video by a single frame.
5	PTZ Button	In Auto-switch mode, it can be used to stop /start auto switch.
6	DEV	Enables/Disables Remote Control.
7	Alphanumeric Buttons	Switch to the corresponding channel in Live view or PTZ Control mode.
		Input numbers and characters in Edit mode.
		Switch between different channels in the Playback mode.
8	ESC Button	Back to the previous menu.
		Press for Arming/disarming the device in Live View mode.
9	PLAY Button	The button is used to enter the All-day Playback mode.
		It is also used to auto scan in the PTZ Control menu.
10	PREV Button	Switch between single screen and multi-screen mode.
		In PTZ Control mode, it is used to adjust the focus in conjunction with the A/FOCUS+ button.

Troubleshooting Remote Control:



Make sure you have install batteries properly in the remote control. And you have to aim the remote control at the IR receiver in the front panel.

If there is no response after you press any button on the remote, follow the procedure below to troubleshoot.

Steps:

1. Go into Menu > Settings > General > More Settings by operating the front control panel or the mouse.
2. Check and remember the DVR No.. The default DVR No. is 255. This number valid for all IR remote controls.
3. Press the DEV button on the remote control.
4. Enter the DVR No. in step 2.
5. Press the ENTER button on the remote.

If the Status indicator on the front panel turns blue, the remote control is operating properly. If the Status indicator does not turn blue and there is still no response from the remote, please check the following:

1. Batteries are installed correctly and the polarities of the batteries are not reversed.

2. Batteries are fresh and not out of charge.
3. IR receiver is not obstructed.

If the remote still cannot function properly, please change the remote and try again, or contact the device provider.

1.3 USB Mouse Operation

A regular 3-button (Left/Right/Scroll-wheel) USB mouse can also be used with this DVR. To use a USB mouse:

Steps:

1. Plug USB mouse into one of the USB interfaces on the front panel of the DVR.
2. The mouse should automatically be detected. If in a rare case that the mouse is not detected, the possible reason may be that the two devices are not compatible, please refer to the recommended the device list from your provider.

The operation of the mouse:

Table 1. 8 Description of the Mouse Control

Name	Action	Description
Left-Click	Single-Click	Live view: Select channel and show the quick set menu. Menu: Select and enter.
	Double-Click	Live view: Switch between single-screen and multi-screen.
	Click and Drag	PTZ control: Wheeling. Privacy mask and motion detection: Select target area. Digital zoom-in: Drag and select target area. Live view: Drag channel/time bar.
Right-Click	Single-Click	Live view: Show menu. Menu: Exit current menu to upper level menu.
Scroll-Wheel	Scrolling up	Live view: Previous screen. Menu: Previous item.
	Scrolling down	Live view: Next screen. Menu: Next item.

1.4 Input Method Description



Figure 1. 9 Soft Keyboard

Description of the buttons on the soft keyboard:

Table 1. 9 Description of the Soft Keyboard Icons

Icon	Description	Icon	Description
	Number		English letter
	Lowercase/Uppercase		Backspace
	Switch the keyboard		Space
	Positioning the cursor		Exit
	Symbols		Reserved

1.5 Rear Panel



The rear panel varies according to different models. Please refer to the actual product. The following figures are for reference only.

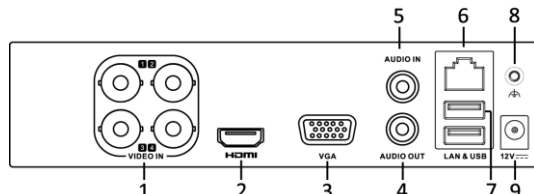

Figure 1. 10 DS-7100

Table 1. 10 Description of Front Panel

No.	Item	Description
1	VIDEO IN	BNC interface for TVI and analog video input.
2	HDMI	HDMI video output connector.
3	VGA	DB15 connector for VGA output. Display local video output and menu.
4	AUDIO OUT	RCA connector.
5	AUDIO IN	RCA connector.
6	Network Interface	Connector for network
7	USB Port	Universal Serial Bus (USB) port for additional devices.
8	GND	Ground
9	Power Supply	12 VDC power supply.

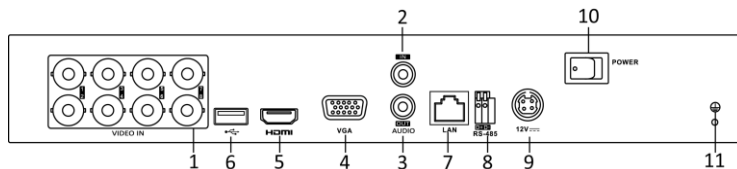

Figure 1. 11 DS-7200HGHI

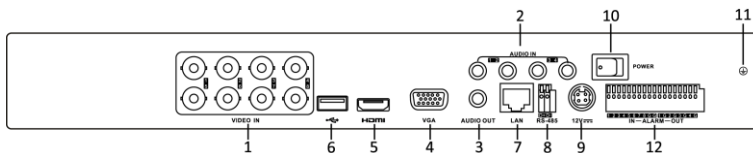

Figure 1. 12 DS-7200HQHI

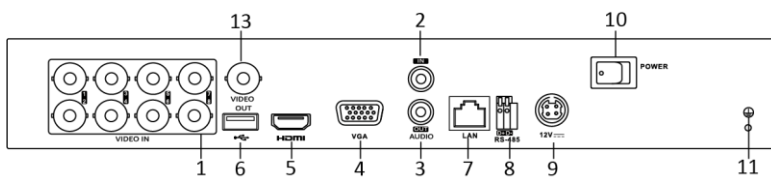

Figure 1. 13 DS-7200HQHI-E1/E2

Table 1. 11 Description of Front Panel

No.	Item	Description
1	VIDEO IN	BNC interface for TVI and analog video input.
2	AUDIO IN	RCA connector
3	AUDIO OUT	RCA connector
4	VGA	DB15 connector for VGA output. Display local video output and menu.
5	HDMI	HDMI video output connector.
6	USB Port	Universal Serial Bus (USB) port for additional devices.
7	Network Interface	Connector for network
8	RS-485 Interface	Connector for RS-485 devices.
9	Power Supply	12V DC power supply.
10	Power Switch	Switch for turning on/off the device.
11	GND	Ground
12	Alarm In/Out (for DS-7200HQHI-SH only)	Connectors for alarm inputs and alarm outputs.
13	VIDE OUT (for DS-7200HQHI-E1/E2 only)	BNC connector for video output.

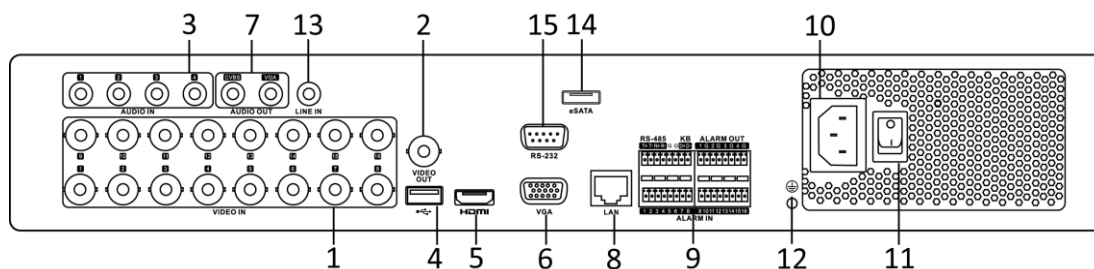

Figure 1. 14 DS-7316HQHI-SH and DS-7316HGHI-SH

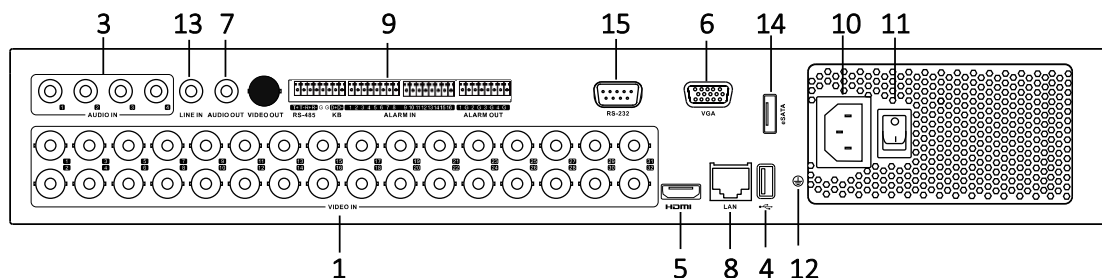

Figure 1. 15 DS-7332HGHI-SH

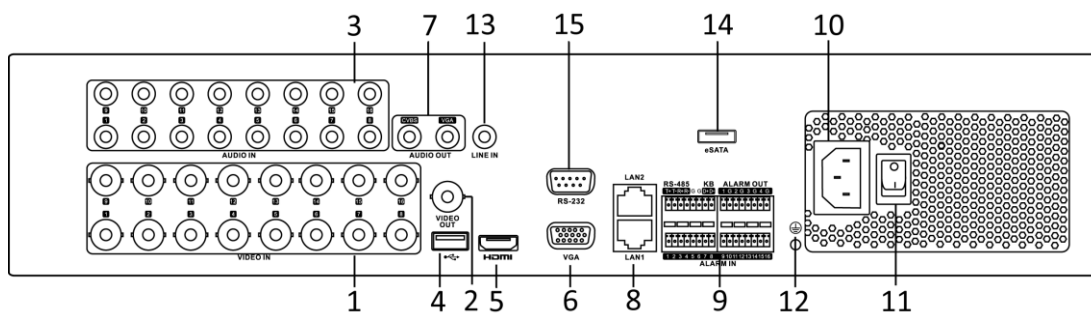

Figure 1. 16 DS-8116HGHI-SH

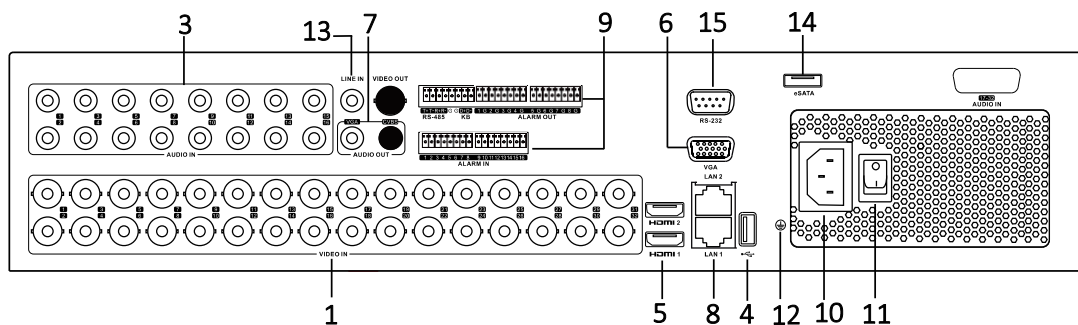

Figure 1. 17 DS-8132HGHI-SH

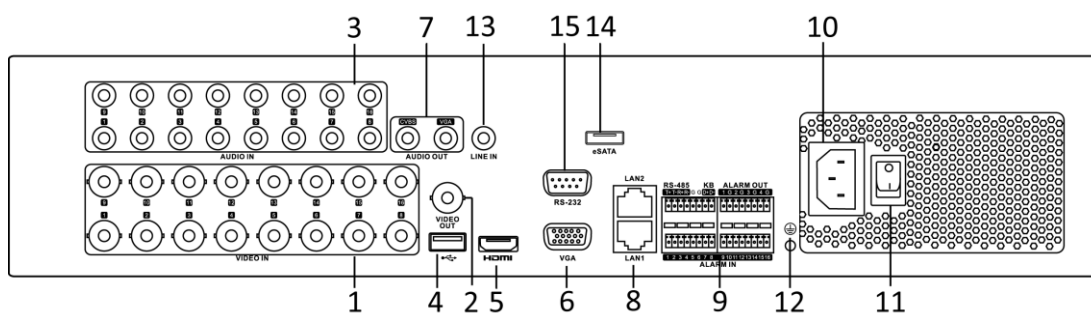



Figure 1. 18 DS-8100/9000HQHI-SH

Table 1. 12 Description of Front Panel

No.	Item	Description
1	VIDEO IN	BNC interface for TVI and analog video input.
2	VIDEO OUT	BNC connector for video output.  CVBS output is not provided by DS-7324/7332HGHI-SH and DS-8124/8132HGHI-SH series.
3	AUDIO IN	RCA connector
4	USB Port	Universal Serial Bus (USB) port for additional devices.
5	HDMI	HDMI video output connector. DS-8124/8132HGHI-SH provides HDMI1 and HDMI2 interfaces.
6	VGA	DB15 connector for VGA output. Display local video output and menu.
7	AUDIO OUT	RCA connector.
8	Network Interface	Connector for network

No.	Item	Description
9	RS-485 Interface	Connector for RS-485 devices. T+ and T- pins connect to R+ and R- pins of PTZ receiver respectively.
		D+, D- pin connects to Ta, Tb pin of controller. For cascading devices, the first DVR's D+, D- pin should be connected with the D+, D- pin of the next DVR.
		Connector for alarm input.
		Connector for alarm output.
10	Power Supply	100 ~ 240V AC power supply.
11	Power Switch	Switch for turning on/off the device.
12	GND	Ground
13	LINE IN	BNC connector for audio input.
14	eSATA	Connects external SATA HDD, CD/DVD-RW.
15	RS-232 Interface	Connector for RS-232 devices.

Chapter 2 Getting Started

2.1 Starting Up and Shutting Down the DVR

Purpose:

Proper startup and shutdown procedures are crucial to expanding the life of the DVR.

Before you start:

Check that the voltage of the extra power supply is the same with the DVR's requirement, and the ground connection is working properly.

Starting up the DVR

Steps:

1. Check the power supply is plugged into an electrical outlet. It is **HIGHLY** recommended that an Uninterruptible Power Supply (UPS) be used in conjunction with the device.
2. Turn on the power switch on the rear panel, and the Power indicator LED should turn on indicating that the unit begins to start up.
3. After startup, the Power indicator LED remains on.

Shutting down the DVR

Steps:

There are two proper ways to shut down the DVR. To shut down the DVR:

- **OPTION 1: Standard shutdown**

1. Enter the Shutdown menu.

Menu > Shutdown

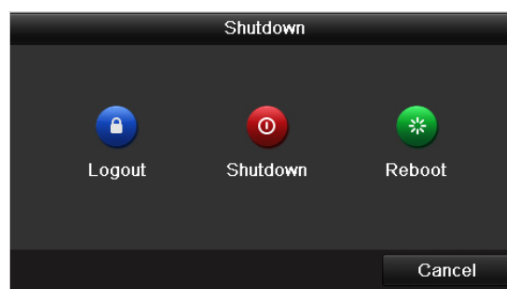

Figure 2. 1 Shutdown Menu

2. Select the **Shutdown** button.
3. Click the **Yes** button.
4. Turn off the power switch on the rear panel when the note appears (for DS-7200 and DS-7100 series).

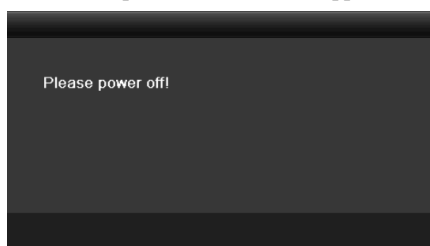

Figure 2. 2 Shutdown Tips

- **OPTION 2: By operating the front panel (for DS-7300 and DS-8100 series)**

1. Press and hold the POWER button on the front panel for 3 seconds.
2. Enter the administrator's username and password in the dialog box for authentication.
3. Click the **Yes** button.



- Do not press the POWER button again when the system is shutting down.
- The device remains standby mode after shutting down, and the POWER indicator turns red; you can turn on the device by pressing the POWER button on the remote control.

Rebooting the DVR

While in the Shutdown menu (Figure 2. 1), you can also reboot the DVR.

Steps:

1. Enter the **Shutdown** menu by clicking Menu > Shutdown.
2. Click the **Logout** button to log out or the **Reboot** button to reboot the DVR.

2.2 Activating the Device

Purpose:

For the first-time access, you need to activate the device by setting an admin password. No operation is allowed before activation. You can also activate the device via Web Browser, SADP or Client Software.

Steps:

1. Input the same password in the text field of **Create New Password** and **Confirm New Password**.

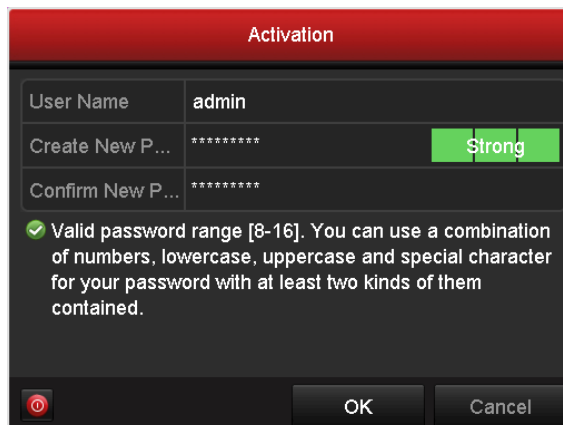

Figure 2.3 Settings Admin Password



STRONG PASSWORD RECOMMENDED– We highly recommend you create a strong password of your own choosing (using a minimum of 8 characters, including upper case letters, lower case letters, numbers, and special characters) in order to increase the security of your product. And we recommend you reset your password regularly, especially in the high security system, resetting the password monthly or weekly can better protect your product.

2. Click **OK** to save the password and activate the device.



For the old version device, if you update it to the new version, the following dialog box will pop up once the device starts up. You can click **YES** and follow the wizard to set a strong password.

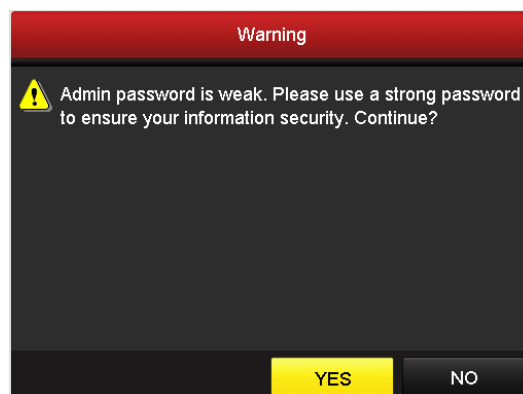

Figure 2.4 Warning

2.3 Basic Configuration in Startup Wizard

2.3.1 Configuring the Signal Input Channel

After the startup and login, the device system enters the Wizard for configuring the signal input.



You can also click **Menu > Camera > Signal Input Status** to configure the signal input.

Steps:

1. Check the checkbox to select different signal input types: TVI, or AHD/CVBS.
2. Click **Apply** to save the settings.

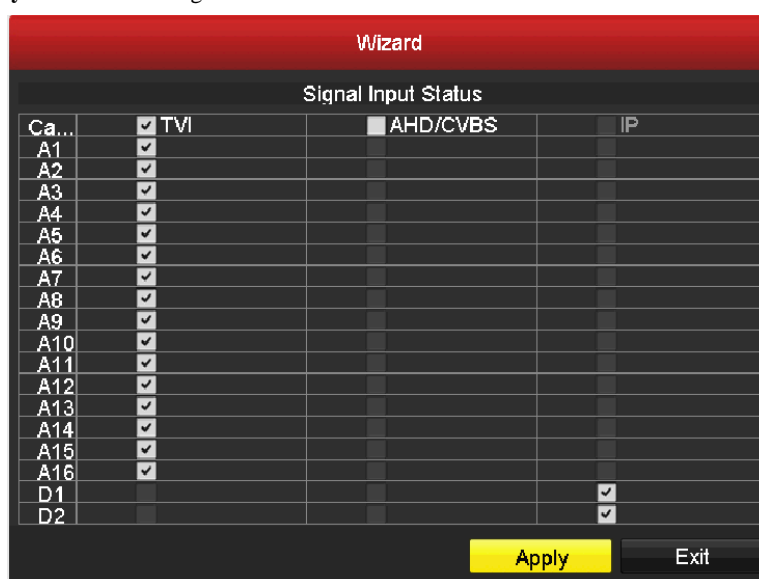

Figure 2. 5 Configure Signal Input Type



- The AHD signal input is supported by the DS-7100HGHI-F1, DS-7200HGHI-F1 and DS-7200HGHI-F2 series DVR only.
- The IP camera connection is not supported by DS-7100 series DVR.

2.3.2 Using the Wizard for Basic Configuration

The Start Wizard can walk you through some important settings of the device. If you don't want to use the Start Wizard at that moment, click **Exit**. You can also choose to use the Start Wizard next time by leaving the "Start wizard when device starts?" checkbox checked.

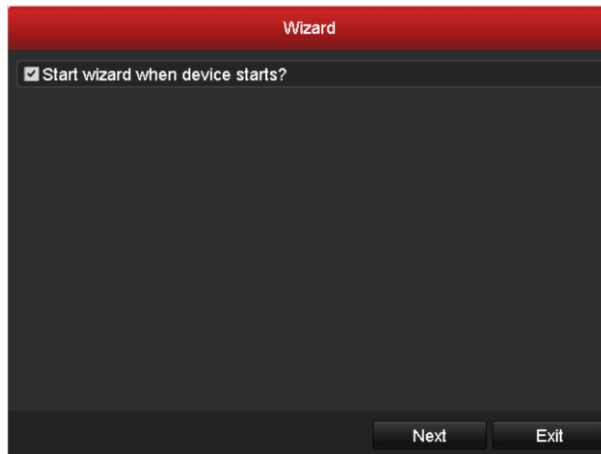

Figure 2. 6 Start Wizard Interface

Steps:

1. Click **Next** to enter the date and time settings window.



Figure 2. 7 Date and Time Settings

2. After the time settings, click **Next** button which will take you back to the General Network Setup Wizard window, as shown in Figure 2. 8.

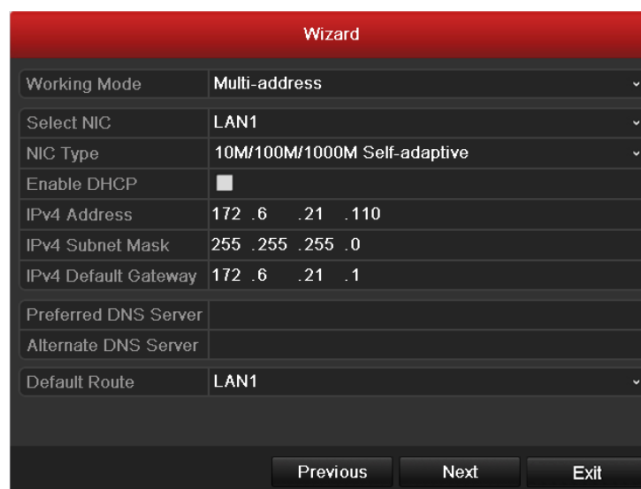

Figure 2. 8 General Network Configuration



1 self-adaptive 10M/100M network interface for DS-7100, DS-7204/7208HGHI-SH, DS-7200HGHI-E1/E2, DS-7200HGHI-F1/F2 and DS-7204/7208HQHI-E1; 2 self-adaptive 10M/100M/1000M network interfaces for DS-8100HQHI&HGHI-SH and DS-9000HQHI-SH series, with three working modes configurable: multi-address, load balance, network fault tolerance; and 1 self-adaptive 10M/100M/1000M network interface for other models.

3. Click **Next** button after you configured the basic network parameters. Then you will enter the **EZVIZ Cloud P2P** interface. Configure the EZVIZ Cloud P2P according to your need.



Figure 2. 9 Advanced Network Configuration

4. Click **Next** button to enter the **Advanced Network Parameter** interface. You can enable PPPoE, enable DDNS and set other ports according to your need.

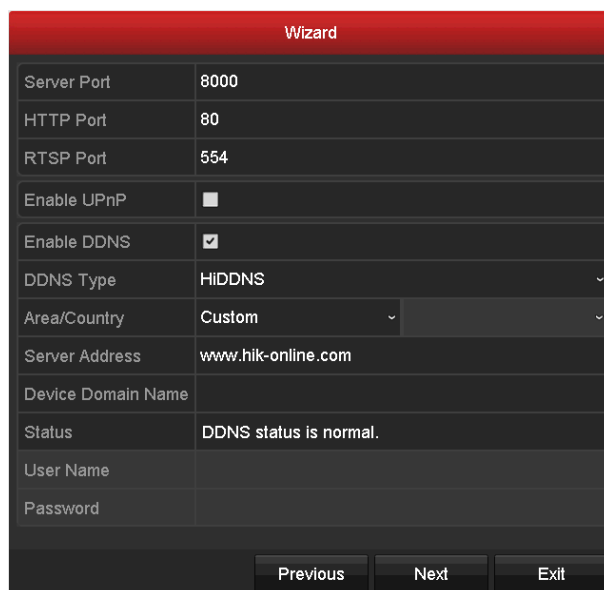

Figure 2. 10 Advanced Network Parameters

5. Click **Next** button after you configured the network parameters, which takes you to the RAID

configuration window (for DS-9000-SH only).

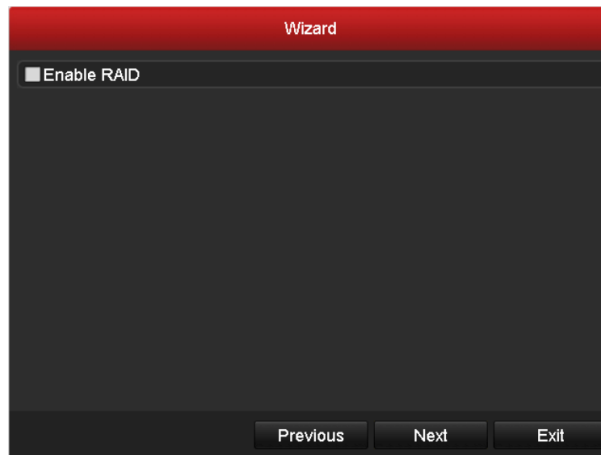

Figure 2. 11 Array Management

6. Click **Next** to the **HDD Management** window, shown in Figure 2. 12.

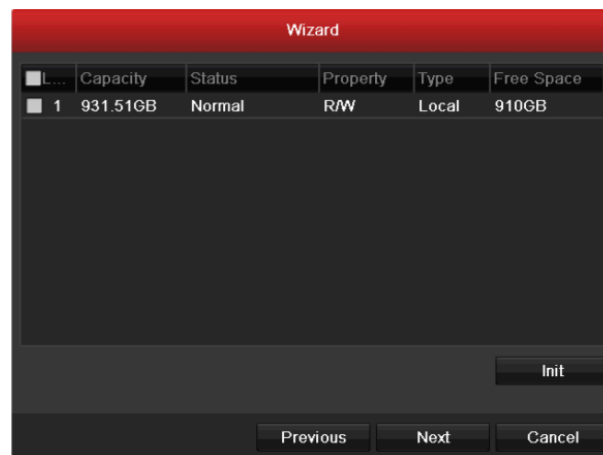

Figure 2. 12 HDD Management

7. To initialize the HDD, click the **Init** button. Initialization will remove all the data saved in the HDD.
8. Click **Next** to enter the **IP Camera Management** window.
9. Click **Search** to search the online IP Camera and the **Security** status shows whether it is active or inactive. Before adding the camera, make sure the IP camera to be added is in active status. If the camera is in inactive status, you can click the inactive icon of the camera to set the password to activate it. You can also select multiple cameras from the list and click the **One-touch Activate** to activate the cameras in batch. Click the **Add** to add the camera.

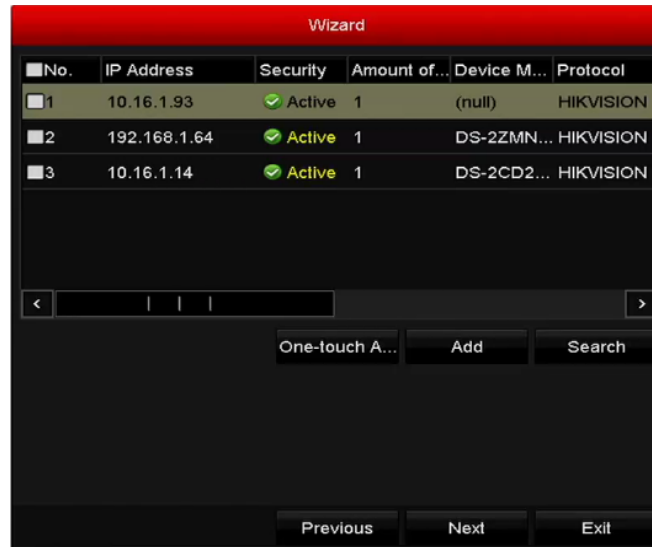



Figure 2. 13 IP Camera Management

10. After finishing IP Camera settings, click **Next** to enter the **Record Settings** window.

11. Click the icon , and you can enable the continuous recording or motion Detection recording for all channels of the device.

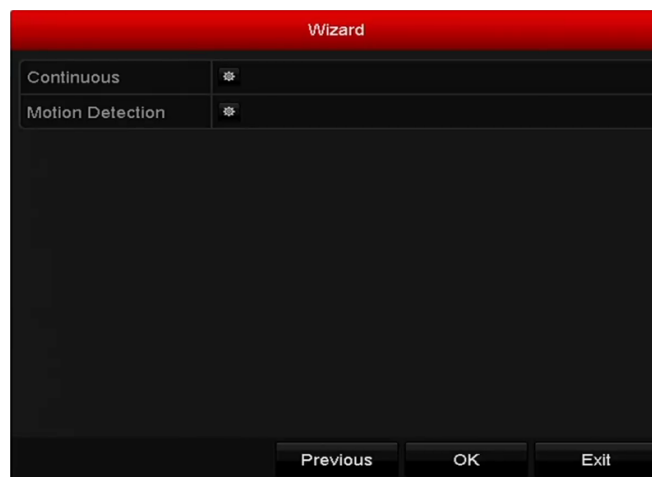

Figure 2. 14 Record Settings

12. Click **OK** to complete the wizard settings.

2.4 Login and Logout

2.4.3 User Login

Purpose:

If the device has logged out, you must login the device before operating the menu and other functions.

Steps:

1. Select the **User Name** in the dropdown list.

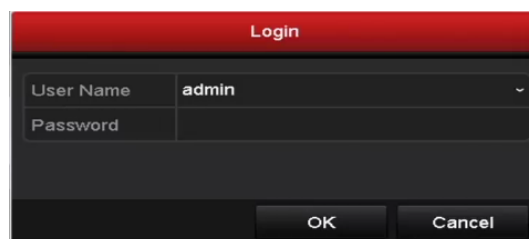

Figure 2. 15 Login Interface

2. Input **Password**.
3. Click **OK** to log in.



In the Login dialog box, if you have entered the wrong password for 7 times, the current user account will be locked for 60 seconds.

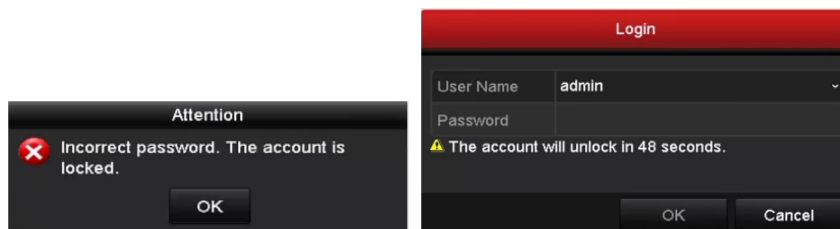

Figure 2. 16 User Account Protection

2.4.4 User Logout

Purpose:

After logging out, the monitor turns to the live view mode and if you want to perform some operation, you need to enter user name and password log in again.

Steps:

1. Enter the Shutdown menu.
Menu > Shutdown

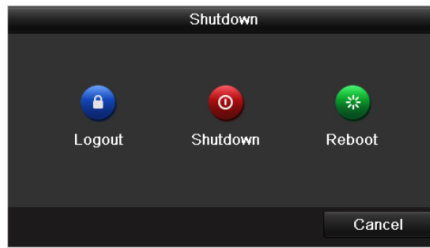

Figure 2. 17 Logout

2. Click Logout.



After you have logged out the system, menu operation on the screen is invalid. It is required to input a user name and password to unlock the system.

2.5 Adding and Connecting the IP Cameras



This section is not available for the DS-7100 series DVR.

2.5.5 Activating the IP Camera

Purpose:

Before adding the camera, make sure the IP camera to be added is in active status.

Steps:

1. Select the **Add IP Camera** option from the right-click menu in live view mode or click Menu> Camera> Camera to enter the IP camera management interface.

For the IP camera detected online in the same network segment, the **Security** status shows whether it is active or inactive.

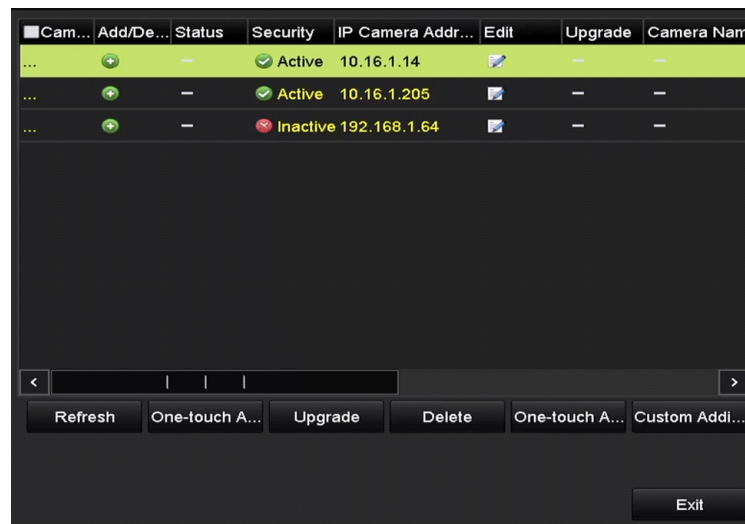

Figure 2. 18 IP Camera Management Interface

2. Click the inactive icon of the camera to enter the following interface to activate it. You can also select multiple cameras from the list and click the **One-touch Activate** to activate the cameras in batch.

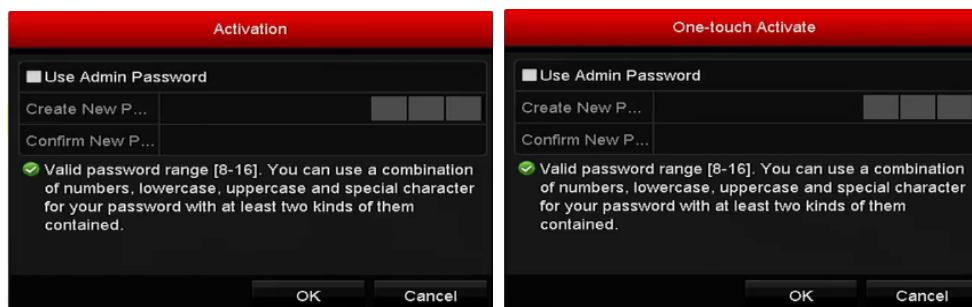

Figure 2. 19 Activate the Camera

3. Set the password of the camera to activate it.

Use Admin Password: when you check the checkbox, the camera (s) will be configured with the same admin password of the operating NVR.



Figure 2. 20 Set New Password

Create New Password: If the admin password is not used, you must create the new password for the camera and confirm it.



STRONG PASSWORD RECOMMENDED – We highly recommend you create a strong password of your own choosing (using a minimum of 8 characters, including upper case letters, lower case letters, numbers, and special characters) in order to increase the security of your product. And we recommend you reset your password regularly, especially in the high security system, resetting the password monthly or weekly can better protect your product.

4. Click **OK** to finish the activating of the IP camera. And the security status of camera will be changed to **Active**.

2.5.6 Adding the Online IP Cameras

Purpose:

Before you can get a live view or record of the video, you should add the network cameras to the connection list of the device.

Before you start:

Ensure the network connection is valid and correct. For detailed checking and configuring of the network, please see *Chapter 11*.

- **OPTION 1:**

Steps:

1. Select the **Add IP Camera** option from the right-click menu in live view mode or click Menu> Camera> Camera to enter the IP camera management interface.

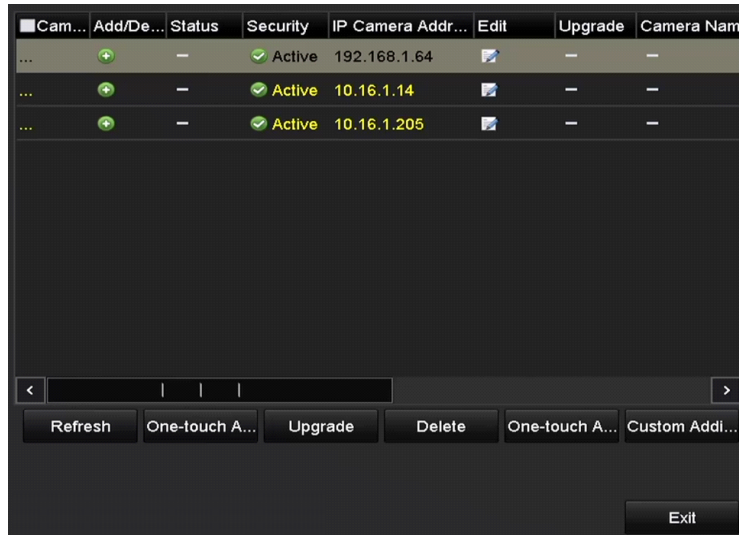



Figure 2. 21 Adding IP Camera Interface

2. The online cameras with same network segment will be detected and displayed in the camera list.
3. Select the IP camera from the list and click the  button to add the camera (with the same admin password of the DVR's). Or you can click the **One-touch Adding** button to add all cameras (with the same admin password) from the list.



Make sure the camera to add has already been activated by setting the admin password, and the admin password of the camera is the same with the DVR's.

4. (For the encoders with multiple channels only) check the checkbox of Channel Port in the pop-up window, as shown in the following figure, and click **OK** to add multiple channels.

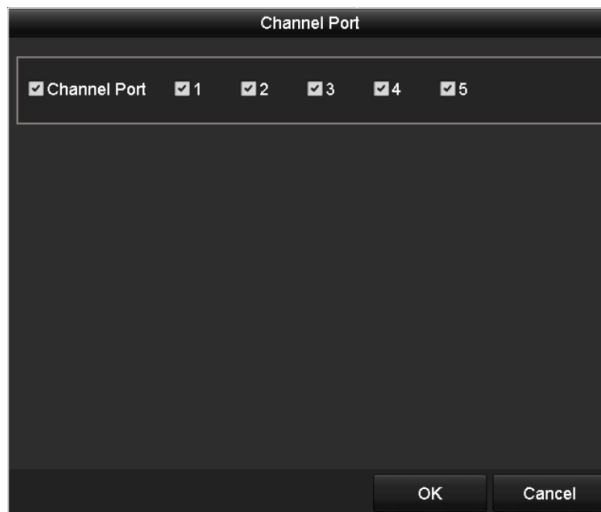

Figure 2. 22 Selecting Multiple Channels

• **OPTION 2:**

Steps:

- 1) On the IP Camera Management interface, click the **Custom Adding** button to pop up the Add IP

Camera (Custom) interface.



Figure 2. 23 Custom Adding IP Camera Interface

- 2) You can edit the IP address, protocol, management port, and other information of the IP camera to be added.

If the IP camera to add has not been activated, you can activate it from the IP camera list on the camera management interface.

- 3) Click **Add** to add the camera.

For the successfully added IP cameras, the Security status shows the security level of the password of camera: strong password, weak password and risk password.

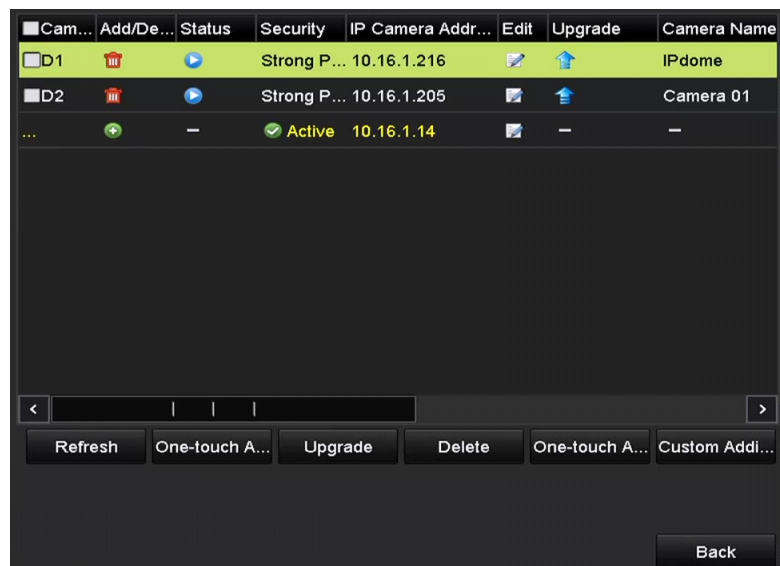

Figure 2. 24 Successfully Added IP Cameras

For the DS-7200 series DVR, 1-ch or 2-ch IP cameras can be added, and for the DS-7300/8100/9000 series DVR, 1 more IP camera can be added by disabling 1 analog channel, and up to 32 IP cameras can be added. Please refer to the following table for the number of connectable IP cameras for different models.

Table 2. 1 Connectable IP Cameras for Different Models

Series	Models	Number of Connectable IP Cameras		
		Default (without disabling channel)	(without analog)	Max. Number (by disabling all analog channels)
DS-7200HGHI-E1	DS-7204HGHI-E1	1-ch		1-ch
	DS-7208HGHI-E1	2-ch		2-ch
	DS-7216HGHI-E1	2-ch		2-ch
DS-7200HGHI-E2	DS-7208HGHI-E2	2-ch		2-ch
	DS-7216HGHI-E2	2-ch		2-ch
DS-7200HGHI-F1	DS-7204HGHI-F1	1-ch		1-ch
	DS-7208HGHI-F1	2-ch		2-ch
	DS-7216HGHI-F1	2-ch		2-ch
DS-7200HGHI-F2	DS-7208HGHI-F2	2-ch		2-ch
	DS-7216HGHI-F2	2-ch		2-ch
DS-7200HGHI-SH	DS-7204HGHI-SH	1-ch		1-ch
	DS-7208HGHI-SH	2-ch		2-ch
	DS-7216HGHI-SH			
DS-7200HQHI-SH	DS-7204HQHI-SH	2-ch		2-ch
	DS-7208HQHI-SH			
	DS-7216HQHI-SH			
DS-7200HQHI-E1/E2	DS-7204HQHI-E1	1-ch		1-ch
	DS-7208HQHI-E1	2-ch		2-ch
	DS-7216HQHI-E2			
DS-7300HGHI-SH	DS-7304HGHI-SH	1-ch		5-ch
	DS-7308HGHI-SH	2-ch		10-ch
	DS-7316HGHI-SH	2-ch		18-ch
	DS-7324HGHI-SH	8-ch		32-ch
	DS-7332HGHI-SH			
DS-7300HQHI-SH	DS-7304HQHI-SH	2-ch		6-ch
	DS-7308HQHI-SH			10-ch
	DS-7316HQHI-SH			18-ch
DS-8100HGHI-SH	DS-8104HGHI-SH	1-ch		5-ch
	DS-8108HGHI-SH	2-ch		10-ch
	DS-8116HGHI-SH	2-ch		18-ch
	DS-8124HGHI-SH	16-ch		32-ch
	DS-8132HGHI-SH			
DS-8100HQHI-SH	DS-8104HQHI-SH	2-ch		6-ch
	DS-8108HQHI-SH			10-ch
	DS-8116HQHI-SH			18-ch
DS-9000HQHI-SH	DS-9004HQHI-SH	6-ch		10-ch
	DS-9008HQHI-SH	10-ch		18-ch
	DS-9016HQHI-SH	18-ch		32-ch



Please refer to the Appendix for the list of compatible IP cameras.

Table 2. 2 Explanation of the icons

Icon	Explanation	Icon	Explanation
	Edit basic parameters of the camera		Add the detected IP camera.
	The camera is disconnected; you can click the icon to get the exception information of camera.		Delete the IP camera
	Play the live video of the connected camera.		Advanced settings of the camera.
	Upgrade the connected IP camera.	Security	Show the security status of the camera to be active/inactive or the password strength (strong/medium/weak/risk)

2.5.7 Editing the Connected IP Cameras



This section is provided for the DS-7300 and DS-8100 models only which support the ONVIF protocol. After the adding of the IP cameras, the basic information of the camera lists in the page, you can configure the basic setting of the IP cameras.

Steps:

1. Click the icon to edit the parameters; you can edit the IP address, protocol and other parameters.



Figure 2. 25 Edit the Parameters

Channel Port: If the connected device is an encoding device with multiple channels, you can choose the channel to connect by selecting the channel port No. in the dropdown list.

2. Click **OK** to save the settings and exit the editing interface.

To edit advanced parameters:

1. Drag the horizontal scroll bar to the right side and click the  icon.

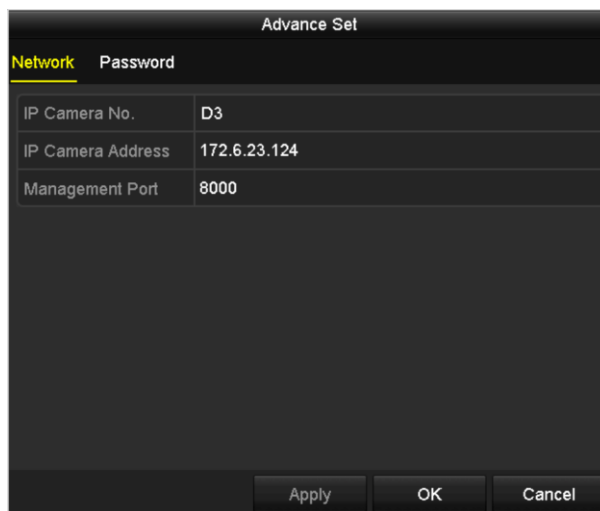

Figure 2. 26 Network Configuration of the Camera

2. You can edit the network information and the password of the camera.

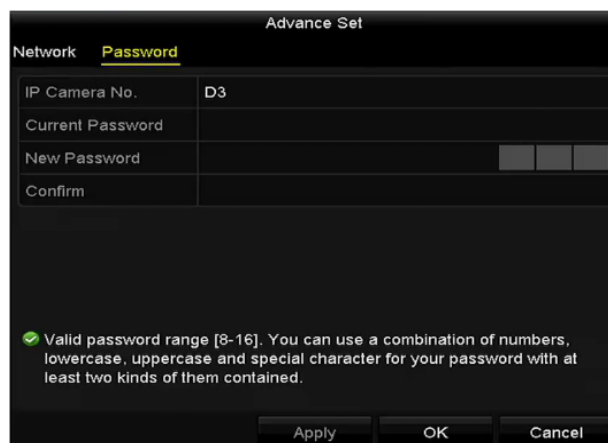

Figure 2. 27 Password Configuration of the Camera

3. Click **OK** to save the settings and exit the interface.

2.6 Configuring the Signal Input Channel

The DS-7100HGHI-F1, DS-7200HGHI-F1 and DS-7200HGHI-F2 series DVR supports the AHD video input. You must define each analog channel to TVI or AHD/CVBS signal input before connecting the camera. And the channel must be connected with the same video input type which you configure on the menu.

Steps:

1. Enter the signal input status interface.

Menu > Camera > Signal Input Status

2. Check the checkbox to select different signal input types: TVI, or AHD/CVBS.

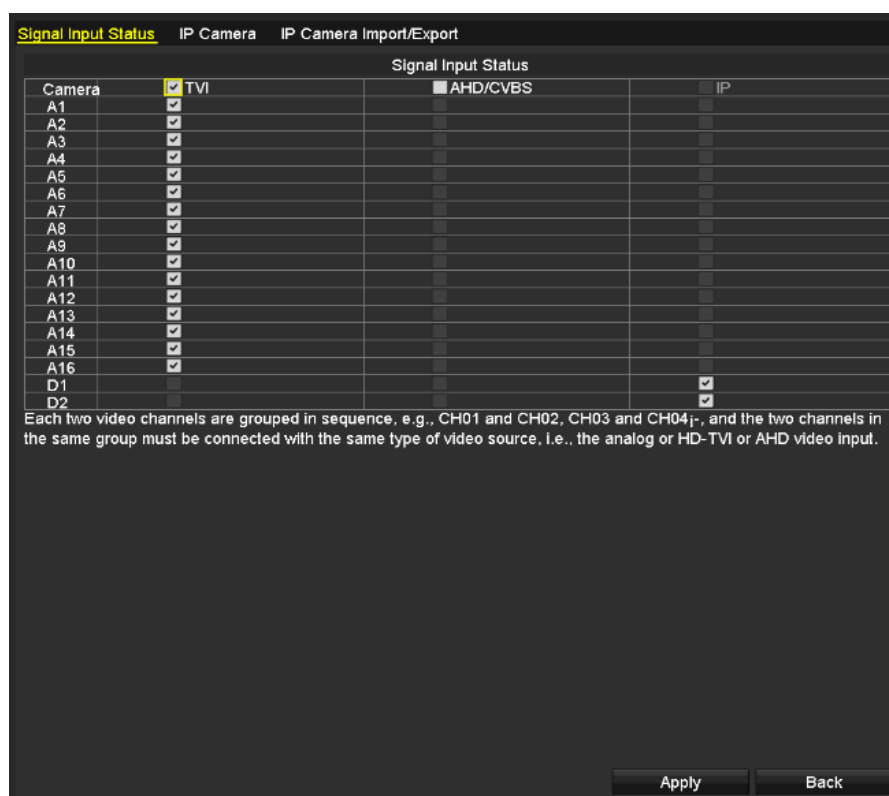

Figure 2. 28 Configure Signal Input Type

3. Click **Apply** to save the settings.



- Each two video channels are grouped in sequence, e.g., CH01 and CH02, CH03 and CH04..., and the two channels in the same group must be connected with the same type of video source, i.e., the analog or HD-TVI or AHD video input.
- In the live view interface, when there is no video signal of the analog channel, the corresponding connectable video signal type message can be displayed on the screen.
- The IP camera connection is not supported by DS-7100 series DVR.

Chapter 3 Live View





3.1 Introduction of Live View

Live view shows you the video image getting from each camera in real time. The DVR will automatically enter Live View mode when powered on. It is also at the very top of the menu hierarchy, thus hitting the ESC many times (depending on which menu you're on) will bring you to the Live View mode.

Live View Icons

In the live view mode, there are icons at the right top of the screen for each channel, showing the status of the record and alarm in the channel, so that you can know whether the channel is recorded, or whether there are alarms occur as soon as possible.

Table 3.1 Description of Live View Icons

Icons	Description
	Alarm (video loss, tampering, motion detection or sensor alarm)
	Record (manual record, schedule record, motion detection or alarm triggered record)
	Alarm & Record
	Event/Exception (motion detection, sensor alarm or exception information. For details, see <i>Chapter 8.7 Handling Exceptions.</i>)



For the DS-7100HGHI-F1, DS-7200HGHI-F1 and DS-7200HGHI-F2 series DVR, when there is no video signal of the analog channel, the corresponding connectable video signal type message can be displayed on the screen, e.g., TVI Channel.

3.2 Operations in Live View Mode

In live view mode, there are many functions provided. The functions are listed below.

- **Single Screen:** show only one screen on the monitor.
- **Multi-screen:** show multiple screens on the monitor simultaneously.
- **Auto-switch:** the screen is auto switched to the next one. And you must set the dwell time for each screen on the configuration menu before enabling the auto-switch. Menu>Configuration>Live View>Dwell Time.
- **Start Recording:** normal record and motion detection record are supported.
- **Quick Set:** select the output mode to Standard, Bright, Gentle or Vivid.
- **Playback:** play back the recorded videos for current day.
- **Aux/Main output switch:** the DVR checks the connection of the output interfaces to define the main and auxiliary output interfaces. When the aux output is enabled, the main output cannot do any operation, and you can do some basic operation on the live view mode for the Aux output.



The DS-7100, DS-7200, and DS-7324/7332HGHI-SH models do not support Aux/Main output switch.

The priority level for the main and aux output for other models is as follows:

- **For the DS-8124/8132HGHI-SH**

The DS-8124/8132HGHI-SH provides HDMI1, HDMI2 and VGA interfaces, and the priority level for the main and aux output is HDMI1/VGA>HDMI2. See the table below.

Table 3. 2 Priorities of Interfaces

S.N	VGA/HDMI1	HDMI2	Main output	Auxiliary output
1	√	√	VGA/HDMI1	HDMI2
2	√	×	VGA/HDMI1	
3	×	√		HDMI2



The √ means the interface is in use, × means the interface is out of use or the connection is invalid. And the HDMI1, VGA and HDMI2 can be used at the same time.

- **For the DS-7308/7316HQHI-SH and DS-8108/8116HQHI-SH**

The DS-7308/7316HQHI-SH and DS-8108/8116HQHI-SH provide the independent HDMI and VGA outputs, and CVBS output. The priority level for the main and aux output is HDMI>VGA>CVBS. See the table below.

Table 3. 3 Priorities of Interfaces

S.N	HDMI	VGA	CVBS	Main output	Auxiliary output
1	√	√	√	HDMI	VGA
2	√	×	√	HDMI	CVBS
3	×	√	√	VGA	CVBS
4	×	×	√	CVBS	



The √ means the interface is in use, × means the interface is out of use or the connection is invalid. And the HDMI, VGA and CVBS can be used at the same time.

For Other Models

For the other models, the priority level for the main and aux output is HDMI/VGA>CVBS. See the table below.

Table 3. 4 Priorities of Interfaces

S.N	VGA/HDMI	CVBS	Main output	Auxiliary output
1	√	√	VGA/HDMI	CVBS
2	√	×	VGA/HDMI	
3	×	√	CVBS	



√ means the interface is in use, × means the interface is out of use or the connection is invalid. And the HDMI, VGA and CVBS can be used at the same time.

3.2.1 Front Panel Operation



This function is not supported by DS-7200HGHI and DS-7100 series.



Table 3. 5 Front Panel Operation in Live View

Functions	Front Panel Operation
Show single screen	Press the corresponding Alphanumeric button. E.g. Press 2 to display only the screen for channel 2.
Show multi-screen	Press the PREV button.
Manually switch screens	Next screen: right direction button. Previous screen: left direction button.
Auto-switch	Press Enter button.
Playback	Press Play button.

3.2.2 Using the Mouse in Live View

Table 3. 6 Mouse Operation in Live View

Name	Description
Menu	Enter the main menu of the system by right clicking the mouse.
Single Screen	Switch to the single full screen by choosing channel number from the dropdown list.
Multi-screen	Adjust the screen layout by choosing from the dropdown list.
Previous Screen	Switch to the previous screen.
Next Screen	Switch to the next screen.

Start/Stop Auto-switch	<p>Enable/disable the auto-switch of the screens.</p> <p> The <i>dwell time</i> of the live view configuration must be set before using Start Auto-switch.</p>
Start Recording	<p>Start recording of all channels, Normal Record and Motion Detection Recording are selectable from the dropdown list.</p>
Add IP Camera	<p>A shortcut to enter the IP camera management interface.(For HDVR series only)</p>
Quick Set	<p>Output Mode is configurable with Standard, Bright, Gentle and Vivid options.</p>
Playback	<p>Enter the playback interface and start playing back the video of the selected channel immediately.</p>
PTZ Control	<p>A shortcut to enter the PTZ control interface of the selected camera.</p>
Aux Monitor	<p>Switch to the auxiliary output mode and the operation for the main output is disabled.</p> <p> If you enter Aux monitor mode and the Aux monitor is not connected, the mouse operation is disabled; you need to switch back to the Main output with the F1 button on front panel or VOIP/MON button on IR remote control and then press the Enter button.</p>

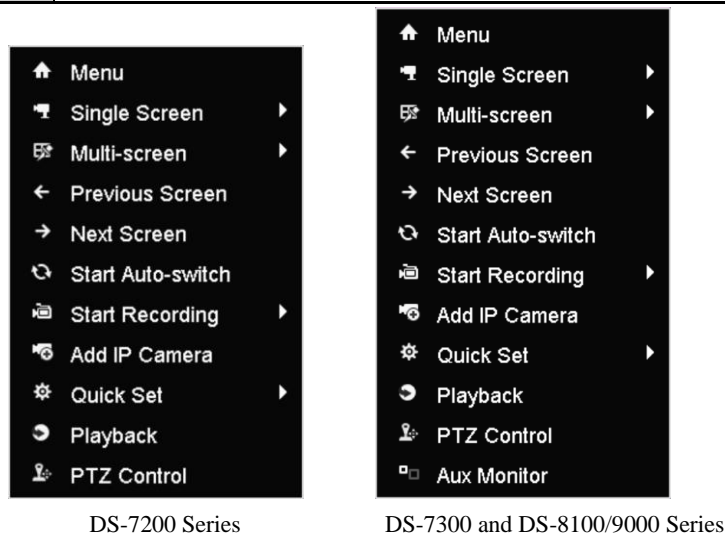

Figure 3. 1 Right-click Menu



The *Add IP Camera* is not supported by DS-7100 series DVR.

3.2.3 Main/Aux Output Switching



The DS-7100, DS-7200, and DS-7324/7332HGHI-SH models do not support Aux/Main output switch. When the HDMI, HDMI/VGA or HDMI1/VGA (DS-8124/8132HGHI-SH) output is configured as the main output, you can perform the following operation to switch to CVBS, VGA or HDMI2 (DS-8124/8132HGHI-SH) output as the main output.

Steps:

1. Use the mouse wheel to double-click on the HDMI (1)/VGA output screen, and the following message box pops up:

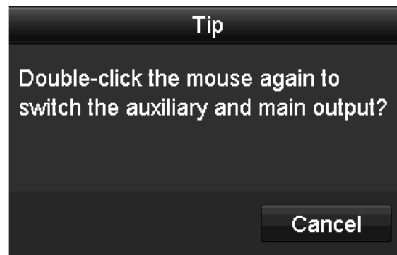

Figure 3. 2 Switch Main and Aux Output

2. Use the mouse wheel to double-click on the screen again to switch to the Aux output, or click **Cancel** to cancel the operation.
3. Select the **Menu Output Mode** to **Main CVBS or HDMI2** from the right-click menu on the monitor.
4. On the pop-up message box, click **Yes** to restart the device to enable the CVBS output or HDMI2 as the main output.



You can select the Menu Output Mode under Menu>Configuration>More Settings to Auto, or HDMI (1)/VGA and then restart the device to switch the main output back to HDMI (1)/VGA output.

3.2.4 Quick Setting Toolbar in Live View Mode

On the screen of each channel, there is a quick setting toolbar which shows when you point the mouse to the bottom of the screen.



Figure 3. 3 Quick Setting Toolbar

Table 3. 7 Description of Quick Setting Toolbar Icons

Icons	Description	Icons	Description	Icons	Description
	Enable/Disable Manual Record		Instant Playback		Mute/Audio on
	PTZ Control		Digital Zoom		Image Settings
	Live View Strategy		Close Live View		



Instant Playback only shows the record in last five minutes. If no record is found, it means there is no record during the last five minutes.



Digital Zoom can zoom in the selected area to the full screen. Click and draw to select the area to zoom in,

as shown in Figure 3. 4.



Figure 3. 4 Digital Zoom



Image Settings icon can be selected to enter the Image Settings menu.

Four modes are selectable according to the real situation:

- **Standard:** for general lighting conditions (default).
- **Indoor:** the image is relatively smoother.
- **Dim Light:** the image is smoother than the other two modes.
- **Outdoor:** the image is relatively clearer and sharper. The degree of contrast and saturation is high.



Figure 3. 5 Image Settings

You can adjust the image parameters, including brightness, contrast, saturation, hue, sharpness and denoising. You can also click **Default** to restore the default settings and click **Copy** to copy the image settings to other analog cameras.

Refer to the *Chapter 11.3 Configuring Video Parameters* for details.



Live View Strategy can be selected to set strategy, including Real-time, Balanced, Fluency.

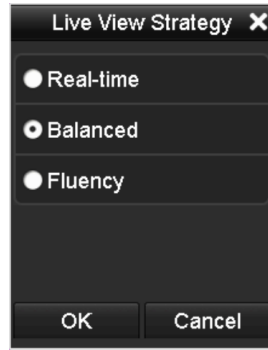

Figure 3. 6 Live View Strategy

3.3 Channel-zero Encoding



This chapter is not applicable to DS-7100 and DS-7200 series DVR

Purpose:

Sometimes you need to get a remote view of many channels in real time from web browser or CMS (Client Management System) software, in order to decrease the bandwidth requirement without affecting the image quality, channel-zero encoding is supported as an option for you.

Steps:

1. Enter the **Live View** Settings interface.

Menu> Configuration> Live View

2. Select the **Channel-Zero Encoding** tab.

A screenshot of a settings interface for Channel-Zero Encoding. It shows a table with four rows: 'Enable Channel-Zero Enc...' with a checked checkbox, 'Frame Rate' set to '12fps', 'Max. Bitrate Mode' set to 'General', and 'Max. Bitrate(Kbps)' set to '1024'. Each row has a dropdown arrow on the right side.

Enable Channel-Zero Enc...	<input checked="" type="checkbox"/>
Frame Rate	12fps
Max. Bitrate Mode	General
Max. Bitrate(Kbps)	1024

Figure 3. 7 Live View- Channel-Zero Encoding

3. Check the checkbox after **Enable Channel-Zero Encoding**.
4. Configure the Frame Rate, Max. Bitrate Mode and Max. Bitrate.
5. Click the **Apply** button to activate the settings.

After you set the Channel-Zero encoding, you can get a view in the remote client or web browser of 16 channels in one screen.

3.4 Adjusting Live View Settings

Purpose:

Live View settings can be customized according to different needs. You can configure the output interface, dwell time for screen to be shown, mute or turning on the audio, the screen number for each channel, etc.

Steps:

1. Enter the Live View Settings interface.

Menu> Configuration> Live View

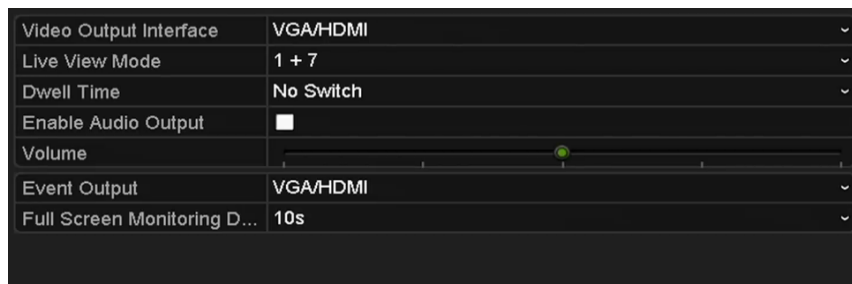

Figure 3. 8 Live View-General

The settings available in this menu include:

- **Video Output Interface:** Designates the output to configure the settings for. The DS-7100, DS-7200, and DS-7324/7332HGHI-SH provide HDMI/VGA outputs; DS-8124/8132HGHI-SH provides HDMI1/VGA and HDMI2 outputs; DS-7308/7316HQHI-SH and DS-8108/8116HQHI-SH provide HDMI, VGA and CVBS outputs; and other models provide HDMI/VGA and CVBS outputs for selection.



The DS-7300-SH and DS-8100-SH provide the Channel-zero video output option for configuring the parameters.

- **Live View Mode:** Designates the display mode to be used for Live View.
 - **Dwell Time:** The time in seconds to *dwell* between switching of channels when enabling auto-switch in Live View.
 - **Enable Audio Output:** Enables/disables audio output for the selected camera in the live view mode.
 - **Volume:** Adjust the volume of the audio output.
 - **Event Output:** Designates the output to show event video; if available, you can select a different video output interface from the Video Output Interface when an event occurs.
 - **Full Screen Monitoring Dwell Time:** The time in seconds to show alarm event screen.
2. Set the camera order.
 - 1) Select **View** tab.

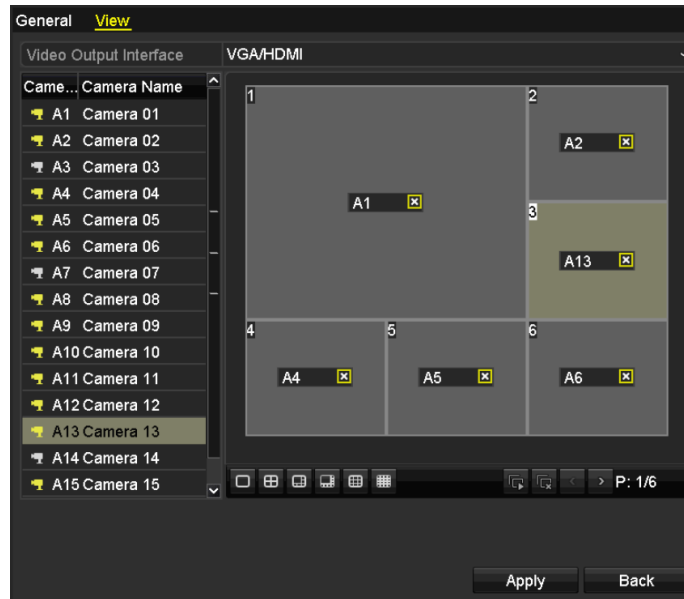





Figure 3. 9 Live View- Camera Order

- 2) Click a window to select it, and then double-click a camera name in the camera list you would like to display. Setting an 'X' means the window will not display any camera.
- 3) You can also click  to start live view of all channels in order and click  to stop live view of all channels. Click  or  to go to the previous or next page.
- 4) Click the **Apply** button.

3.5 Manual Video Quality Diagnostics

Purpose:

The video quality of the analog channels can be diagnosed manually and you can view the diagnostic results from a list.

Steps:

1. Enter the Manual Video Quality Diagnostics interface.

Menu> Manual >Manual Video Quality Diagnostics

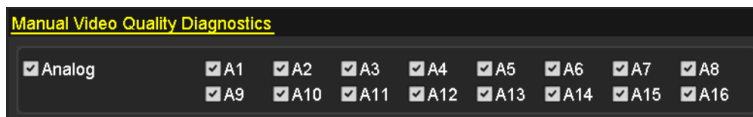

Figure 3. 10 Video Quality Diagnostics

2. Check the checkboxes to select the channels for diagnostics.
3. Click the button **Diagnose**, and the results will be displayed on a list. You can view the video status and diagnostics time of the selected channels.

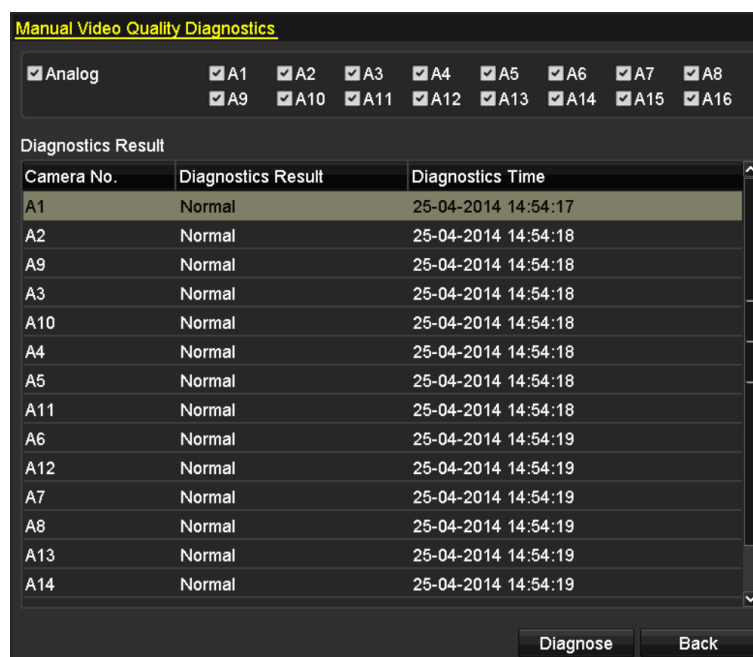

Figure 3. 11 Diagnostics Result



- Connect the camera to the device for the video quality diagnostics.
- Three exception types can be diagnosed: Blurred Image, Abnormal Brightness and Color Cast.

3.6 User Logout

Purpose:

After logging out, the monitor turns to the live view mode and if you want to do some operation, you need to enter user name and password to log in again.

Steps:

3. Enter the Shutdown menu.

Menu>Shutdown

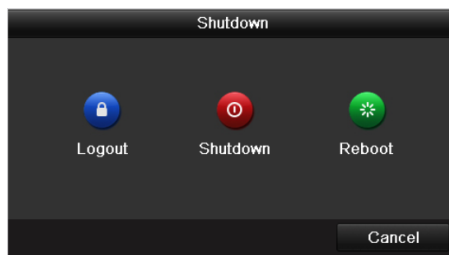

Figure 3.12 Shutdown

4. Click **Logout**.

Chapter 4 PTZ Controls

4.1 Configuring PTZ Settings

Purpose:

The DVR can be connected with the Coaxitron camera/dome and control with the HVISION-C or AHD-C protocol. Follow the procedure to set the parameters for PTZ. The configuring of the PTZ parameters should be done before you control the PTZ camera.

Steps:

1. Enter the PTZ Settings interface.
Menu >Camera> PTZ



Figure 4. 1 PTZ Settings

2. Choose the camera for PTZ setting in the **Camera** dropdown list.
3. Click the **PTZ Parameters** button to set the PTZ parameters.



Figure 4. 2 PTZ- General

4. Enter the parameters of the PTZ camera.

All the parameters should be exactly the same as the PTZ camera parameters.



- For the Coaxitron camera/dome connected, you can select the PTZ protocol to HIKVISION-C (Coaxitron) or AHD-C (Coaxitron). Make sure the protocol selected here is supported by the connected camera/dome.
 - The AHD-C (Coaxitron) is supported by the DS-7100HGHI-F1, DS-7200HGHI-F1 and DS-7200HGHI-F2 series DVR only.
 - When the Coaxitron protocol is selected, all the other parameters like the baud rate, data bit, stop bit, parity and flow control are not configurable.
5. Click **Apply** button to save the settings.

4.2 Setting PTZ Presets, Patrols & Patterns

Before you start:

Please make sure that the presets, patrols and patterns should be supported by PTZ protocols.

4.2.1 Customizing Presets

Purpose:

Follow the steps to set the Preset location which you want the PTZ camera to point to when an event takes place.

Steps:

1. Enter the PTZ Control interface.

Menu>Camera>PTZ



Figure 4.3 PTZ Settings

2. Use the directional button to wheel the camera to the location where you want to set preset; and the zoom and focus operations can be recorded in the preset as well.
3. Enter the preset No. (1~255) in the preset text field, and click the **Set** button to link the location to the preset.
Repeat the steps2-3 to save more presets.
You can click the **Clear** button to clear the location information of the preset, or click the **Clear All** button to clear the location information of all the presets.

4.2.2 Calling Presets

Purpose:

This feature enables the camera to point to a specified position such as a window when an event takes place.

Steps:



1. Click the button **PTZ** in the lower-right corner of the PTZ setting interface;
Or press the PTZ button on the front panel or click the PTZ Control icon  in the quick setting bar, or select the PTZ option in the right-click menu to show the PTZ control panel.
2. Choose **Camera** in the dropdown list.
3. Click the  button to show the general settings of the PTZ control.



Figure 4. 4 PTZ Panel - General

4. Click to enter the preset No. in the corresponding text field.
5. Click the **Call Preset** button to call it.



When the Coaxitron camera/dome connected and the PTZ protocol is selected to HIKVISION-C (Coaxitron), you can call the preset 95 to enter the menu of the connected Coaxitron camera/dome. Use the directional buttons on the PTZ control panel to operate the menu.

4.2.3 Customizing Patrols

Purpose:

Patrols can be set to move the PTZ to different key points and have it stay there for a set duration before moving on to the next key point. The key points are corresponding to the presets. The presets can be set following the steps above in *Customizing Presets*.

Steps:

1. Enter the PTZ Control interface.
Menu>Camera>PTZ



Figure 4. 5 PTZ Settings

2. Select patrol No. in the drop-down list of patrol.
3. Click the **Set** button to add key points for the patrol.

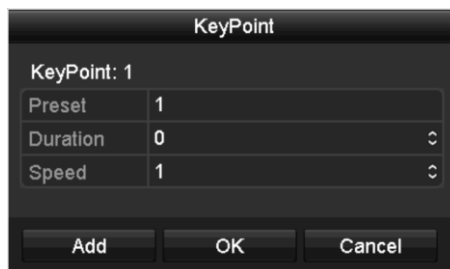

Figure 4. 6 Key point Configuration

4. Configure key point parameters, such as the key point No., duration of staying for one key point and speed of patrol. The key point is corresponding to the preset. The **Key Point No.** determines the order at which the PTZ will follow while cycling through the patrol. The **Duration** refers to the time span to stay at the corresponding key point. The **Speed** defines the speed at which the PTZ will move from one key point to the next.
5. Click the **Add** button to add the next key point to the patrol, or you can click the **OK** button to save the key point to the patrol.
You can delete all the key points by clicking the **Clear** button for the selected patrol, or click the **Clear All** button to delete all the key pints for all patrols.

4.2.4 Calling Patrols

Purpose:

Calling a patrol makes the PTZ to move according the predefined patrol path.

Steps:

1. Click the button **PTZ** in the lower-right corner of the PTZ setting interface;

Or press the PTZ button on the front panel or click the PTZ Control icon  in the quick setting bar, or select the PTZ option in the right-click menu to show the PTZ control panel.

2. Click the  button to show the general settings of the PTZ control.



Figure 4. 7 PTZ Panel - General

3. Select a patrol in the dropdown list and click the **Call Patrol** button to call it.
4. You can click the **Stop Patrol** button to stop calling it.

4.2.5 Customizing Patterns

Purpose:

Patterns can be set by recording the movement of the PTZ. You can call the pattern to make the PTZ movement according to the predefined path.

Steps:

1. Enter the PTZ Control interface.
Menu > Camera > PTZ



Figure 4. 8 PTZ Settings

2. Choose pattern number in the dropdown list.
3. Click the **Start** button and click corresponding buttons in the control panel to move the PTZ camera, and

click the **Stop** button to stop it.

The movement of the PTZ is recorded as the pattern.

4.2.6 Calling Patterns

Purpose:

Follow the procedure to move the PTZ camera according to the predefined patterns.

Steps:



1. Click the button **PTZ** in the lower-right corner of the PTZ setting interface;
Or press the PTZ button on the front panel or click the PTZ Control icon  in the quick setting bar, or select the PTZ option in the right-click menu to show the PTZ control panel.
2. Click the  button to show the general settings of the PTZ control.



Figure 4.9 PTZ Panel - General

3. Click the **Call Pattern** button to call it.
4. Click the **Stop Pattern** button to stop calling it.

4.2.7 Customizing Linear Scan Limit

Purpose:

The Linear Scan can be enabled to trigger the scan in the horizontal direction in the predefined range.

This function is supported by some certain models.

Steps:

1. Enter the PTZ Control interface.
Menu > Camera > PTZ



Figure 4.10 PTZ Settings

2. Use the directional button to wheel the camera to the location where you want to set the limit, and click the **Left Limit** or **Right Limit** button to link the location to the corresponding limit.

The speed dome starts linear scan from the left limit to the right limit, and you must set the left limit on the left side of the right limit, as well the angle from the left limit to the right limit should be no more than 180°.

4.2.8 Calling Linear Scan

Purpose:

Follow the procedure to call the linear scan in the predefined scan range.

Steps:



1. Click the button **PTZ** in the lower-right corner of the PTZ setting interface;
Or press the PTZ button on the front panel or click the PTZ Control icon  in the quick setting bar to enter the PTZ setting menu in live view mode.
2. Click the  button to show the one-touch function of the PTZ control.



Figure 4.11 PTZ Panel - One-touch

3. Click **Linear Scan** button to start the linear scan and click the Linear Scan button again to stop it.
You can click the **Restore** button to clear the defined left limit and right limit data and the dome needs to reboot to make settings take effect.

4.2.9 One-touch Park

Purpose:

For some certain model of the speed dome, it can be configured to start a predefined park action (scan, preset, patrol and etc.) automatically after a period of inactivity (park time).

Steps:



1. Click the button **PTZ** in the lower-right corner of the PTZ setting interface;
Or press the PTZ button on the front panel or click the PTZ Control icon  in the quick setting bar to enter the PTZ setting menu in live view mode.
2. Click the  button to show the one-touch function of the PTZ control.



Figure 4. 12 PTZ Panel - One-touch

3. There are 3 one-touch park types selectable, click the corresponding button to activate the park action.
Park (Quick Patrol): The dome starts patrol from the predefined preset 1 to preset 32 in order after the park time. The undefined preset will be skipped.
Park (Patrol 1): The dome starts move according to the predefined patrol 1 path after the park time.
Park (Preset 1): The dome moves to the predefined preset 1 location after the park time.



The park time can only be set through the speed dome configuration interface, by default the value is 5s.

4. Click the button again to inactivate it.

4.3 PTZ Control Panel

To enter the PTZ control panel, there are two ways supported.

OPTION 1:

In the PTZ settings interface, click the **PTZ** button on the lower-right corner which is next to the Back button.

OPTION 2:

In the Live View mode, you can press the PTZ Control button on the front panel or on the remote control, or choose the PTZ Control icon , or select the PTZ option in the right-click menu.

Click the **Configuration** button on the control panel, and you can enter the PTZ Settings interface.

















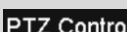

In PTZ control mode, the PTZ panel will be displayed when a mouse is connected with the device. If no mouse is connected, the **PTZ** icon appears in the lower-left corner of the window, indicating that this camera is in PTZ control mode.



Figure 4. 13 PTZ Panel

Table 4. 1 Description of the PTZ panel icons

Icon	Description	Icon	Description	Icon	Description
	Direction button and the auto-cycle button		Zoom+, Focus+, Iris+		Zoom-, Focus-, Iris-
	The speed of the PTZ movement		Light on/off		Wiper on/off
	3D-Zoom		Image Centralization		Menu
	Switch to the PTZ control interface		Switch to the one-touch control interface		Switch to the general settings interface
	Previous item		Next item		Start pattern / patrol
	Stop the patrol / pattern movement		Exit		Minimize windows

Chapter 5 Recording Settings

5.1 Configuring Recording Parameters

Before you start:

1. Make sure that the HDD has already been installed. If not, please install a HDD and initialize it.
(Menu>HDD>General)

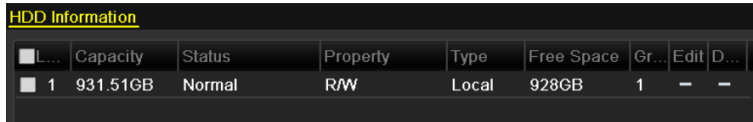

Figure 5. 1 HDD- General

2. Click **Advance** to check the storage mode of the HDD.
 - 1) Whether the HDD mode is *Quota*, please set the maximum record capacity. For detailed information, see *Chapter 10.5 Configuring Quota Mode*.
 - 2) If the HDD mode is *Group*, you should set the HDD group. For detailed information, see *Chapter 5.9 Configuring HDD Group for Recording*.

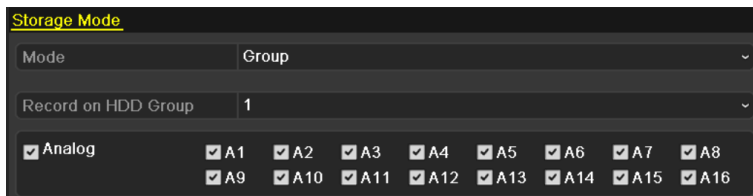

Figure 5. 2 HDD- Advanced

Steps:

1. Enter the Record settings interface to configure the encoding parameters:
Menu>Record>Parameters



Figure 5. 3 Record Parameters

2. Set the parameters for recording.

- 1) Select the **Record** tab to configure.
- 2) Select a camera number in the camera dropdown list.

You can configure the stream type, the resolution, the video quality and other parameters on demand for Main Stream (Continuous) and Main Stream (Event) respectively.



- The resolution of 1920*1080 (lite) is supported by the DS-7200HQHI-E1/E2 models only.
 - Please refer to the *Appendix-Specifications* for the supported resolutions of different models.
- 3) You can configure the advanced parameters, including pre-record, post-record time, expired time, redundant record (this option is only available when the HDD mode is *Group*) and whether you want to record audio.
 - **Pre-record:** The time you set to record before the scheduled time or event. For example, when an alarm triggered the recording at 10:00, if you set the pre-record time as 5 seconds, the camera records it at 9:59:55.
 - **Post-record:** The time you set to record after the event or the scheduled time. For example, when an alarm triggered the recording ends at 11:00, if you set the post-record time as 5 seconds, it records till 11:00:05.
 - **Expired Time:** The expired time is the longest time for a record file to be kept in the HDD, if the deadline is reached, the file will be deleted. You can set the expired time to 0, and then the file will not be deleted. The actual keeping time for the file should be determined by the capacity of the HDD.
 - **Redundant Record:** The redundant record is to decide whether you want the camera to save the record files in the redundant HDD. You must configure the redundant HDD in HDD settings. For detailed information, see *Chapter 5.8 Configuring Redundant Recording*.
 - **Record Audio:** Check the checkbox of Record Audio to record the sound, otherwise record the image without sound.
 - **Video Stream:** Main stream and sub-stream are selectable for recording. When you select sub-stream, you can record for a longer time with the same storage space.
 - **Enable 960 Mode:** The option is supported by analog cameras. Enabling the 960 mode to enable the WD1 resolution for the main stream, otherwise, the resolution supports up to 4CIF. And the option does not supported by TVI cameras, while the WD1 resolution is available all the time.
 - 4) Click **Apply** to save the settings.
 - 5) You can copy the settings to other channels by clicking **Copy**, if the setting can also be used for other cameras.



You can copy the same settings to the cameras with same signal, e.g., the channel No. 1-3 connect to the TVI cameras, and the channel No.4 connects to an analog camera, and then the settings of channel No. 1 can be only copied to channel 2 and 3.

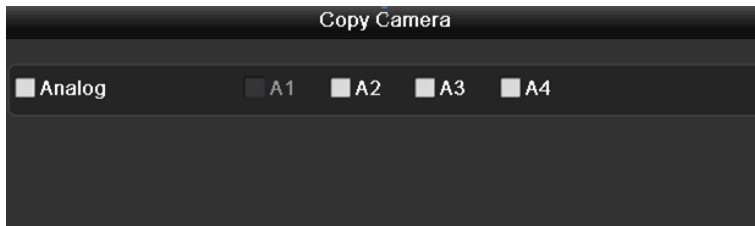

Figure 5. 4 Copy Camera Settings

3. Set encoding parameters for sub-stream.

- 1) Select the **Substream** tab.

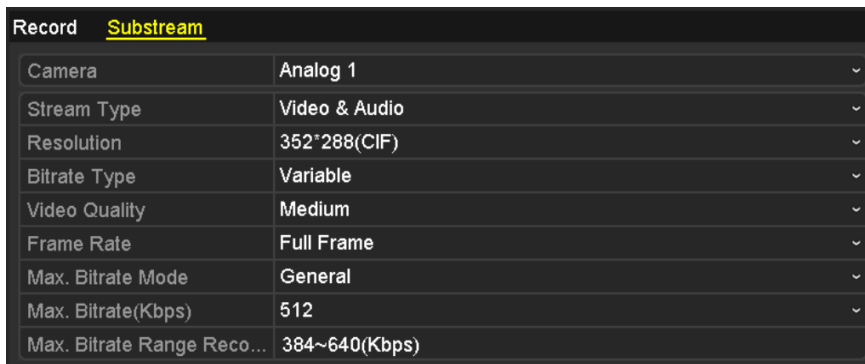

Figure 5. 5 Sub-stream Encoding

- 2) Select a camera in the camera dropdown list.
- 3) Configure the parameters.
- 4) Click **Apply** to save the settings.
- 5) (Optional) If the parameters can also be used to other cameras, click **Copy** to copy the settings to other channels.

5.2 Configuring Record Schedule



The DS-7100 models support the continuous and motion triggered recording only, DS-7200HGHI models support continuous, motion and VCA triggered recording types, and other models support continuous, alarm, motion, motion | alarm, motion & alarm and event triggered recording types.

Purpose:

Set the record schedule, and then the camera will automatically start/stop recording according to the configured schedule.

Steps:

1. Enter the Record Schedule interface.

Menu> Record> Schedule

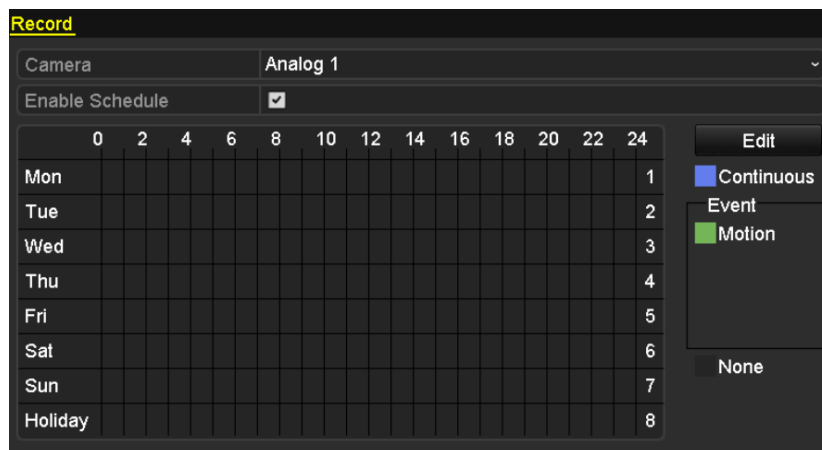

DS-7100 and DS-7200HGHI

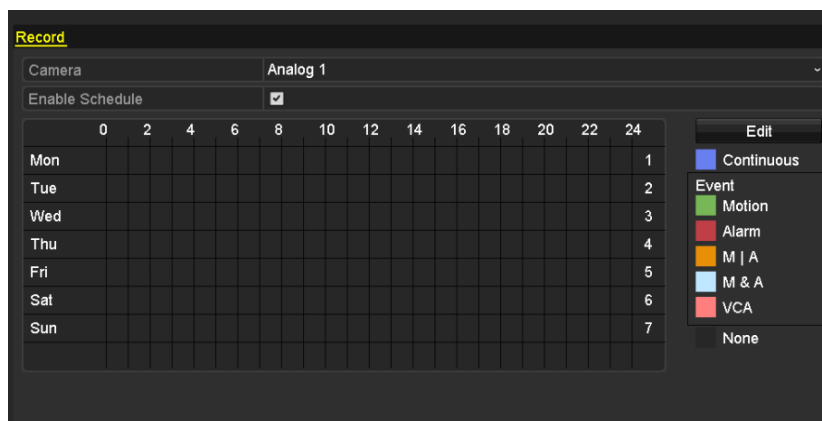

Other Models

Figure 5. 6 Record Schedule

2. Choose the camera you want to configure in the Camera dropdown list.
3. Check the checkbox of Enable Schedule.
4. Configure the record schedule.

Edit the schedule

- 1) Click **Edit**.
- 2) In the message box, you can choose the day to which you want to set schedule.
- 3) To schedule an all-day recording, check the checkbox after the **All Day** item.

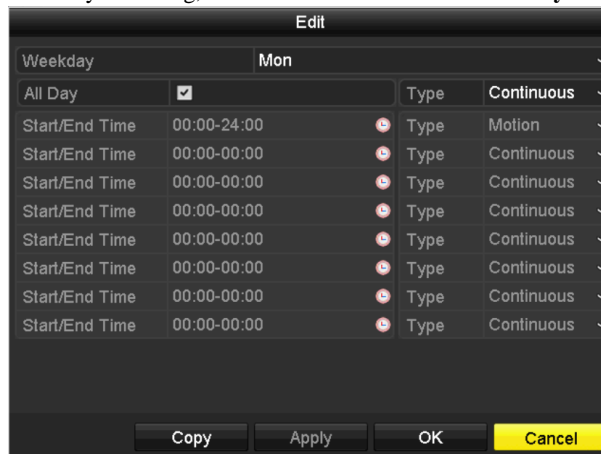

Figure 5.7 Edit Schedule- All Day

- 4) To arrange other schedule, leave the **All Day** checkbox blank and set the Start/End time.

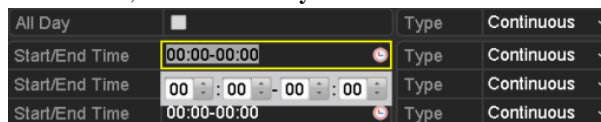

Figure 5.8 Edit Schedule- Set Time Period



Up to 8 periods can be configured for each day. And the time periods cannot be overlapped with each other.

Repeat the above steps 1)-4) to schedule recording for other days in the week. If the schedule can also be set to other days, click **Copy**.

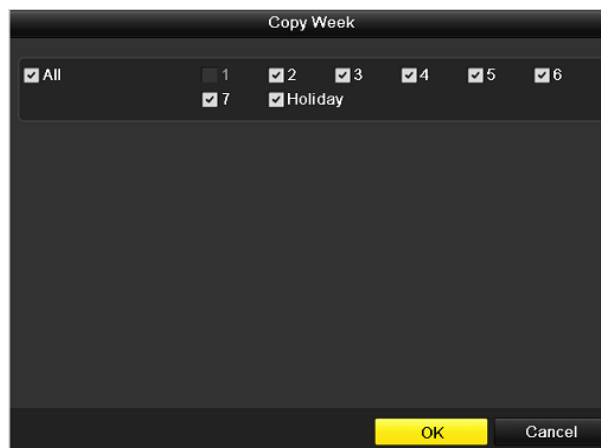

Figure 5.9 Copy Schedule to Other Days



The **Holiday** option is available when you enable holiday schedule in **Holiday settings**. See *Chapter 5.7 Configuring Holiday Record*.

- 5) Click **OK** to save setting and back to upper level menu.

Draw the schedule

- 1) Click on the color icon to select a record type in the event list on the right-side of the interface.



Figure 5. 10 Draw the Schedule

Descriptions of the color icons are shown in the figure below.

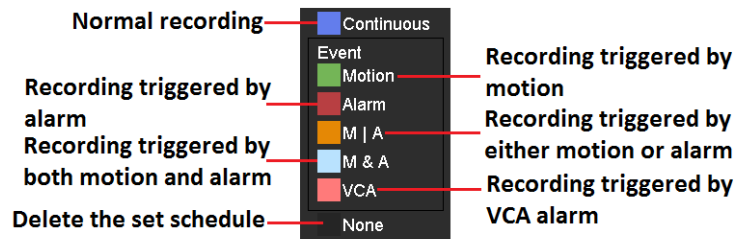

Figure 5. 11 Descriptions of the Color Icons

- 2) Click and drag the mouse on the schedule.
- 3) Click on the other area except for the schedule table to finish and exit the drawing.

You can repeat step 4 to set schedule for other channels. If the settings can also be used to other channels, click **Copy**, and then choose the channel to which you want to copy.

5. Click **Apply** in the Record Schedule interface to save the settings.

5.3 Configuring Motion Detection Record

Purpose:

Follow the steps to set the motion detection parameters. In the live view mode, once a motion detection event takes place, the DVR can analyze it and do many actions to handle it. Enabling motion detection function can trigger certain channels to start recording, or trigger full screen monitoring, audio warning, notifying the surveillance center, sending email and so on.

Steps:

1. Enter the Motion Detection interface.

Menu>Camera>Motion

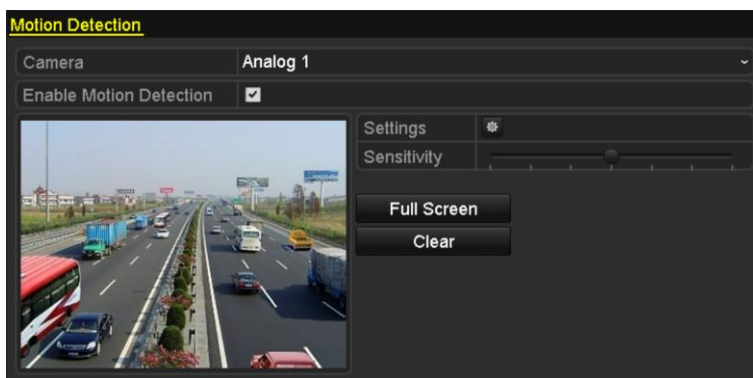

Figure 5.12 Motion Detection

2. Configure Motion Detection:

- 1) Choose camera you want to configure.
- 2) Check the checkbox after **Enable Motion Detection**.
- 3) Drag and draw the area for motion detection by mouse. If you want to set the motion detection for all the area shot by the camera, click **Full Screen**. To clear the motion detection area, click **Clear**.

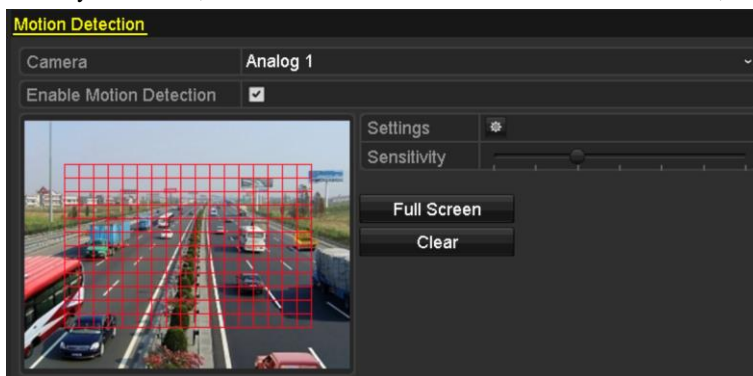

Figure 5.13 Motion Detection- Mask

- 4) Click **Handling**, and the message box for channel information pops up.

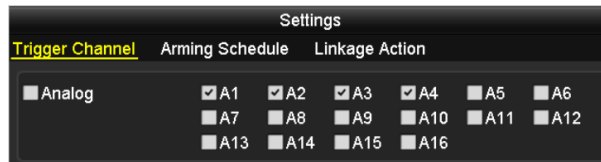

Figure 5. 14 Motion Detection Settings

- 5) Select the channels which you want the motion detection event to trigger recording.
 - 6) Click **Apply** to save the settings.
 - 7) Click **OK** to back to the upper level menu.
 - 8) Exit the Motion Detection menu.
- 3. Configure the schedule.**
- Please refer to the step 4 of *Chapter 5.2 Configuring Record Schedule*, while you may choose Motion as the record type.

5.4 Configuring Alarm Triggered Record



The DS-7100 and DS-7200 series do not support the alarm input.

Purpose:

Follow the procedure to configure alarm triggered recording.

Steps:

1. Enter the Alarm setting interface.

Menu> Configuration> Alarm

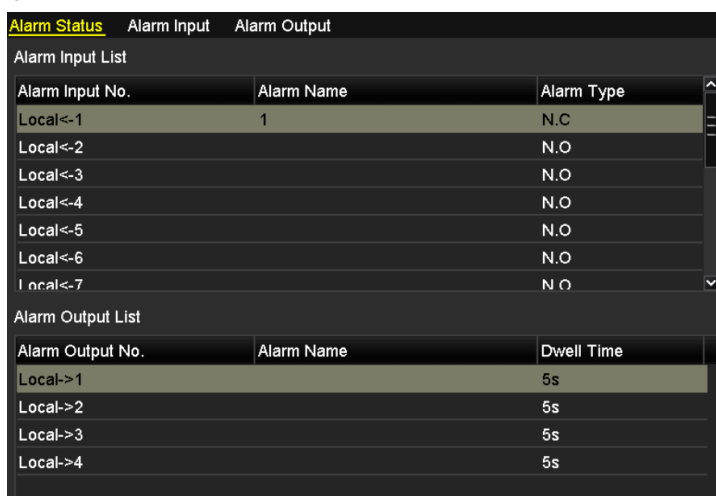

Figure 5. 15 Alarm Settings

2. Click the **Alarm Input** tab.

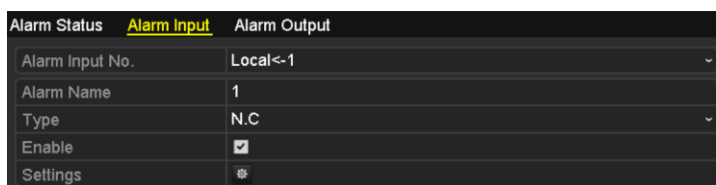

Figure 5. 16 Alarm Settings- Alarm Input

- 1) Select Alarm Input number and configure alarm parameters.
- 2) Choose N.O (normally open) or N.C (normally closed) for alarm type.
- 3) Check the checkbox of Setting.
- 4) Click the button.

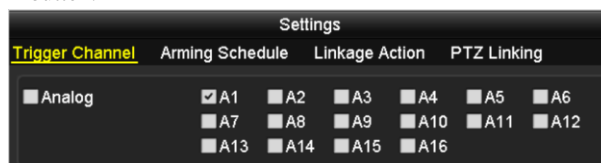

Figure 5. 17 Alarm Handling

- 5) Choose the alarm triggered recording channel.

- 6) Check the checkbox to select channel.
- 7) Click **Apply** to save settings.
- 8) Click **OK** to back to the upper level menu.

Repeat the above steps to configure other alarm input parameters.

If the setting can also be applied to other alarm inputs, click **Copy** and choose the alarm input number.

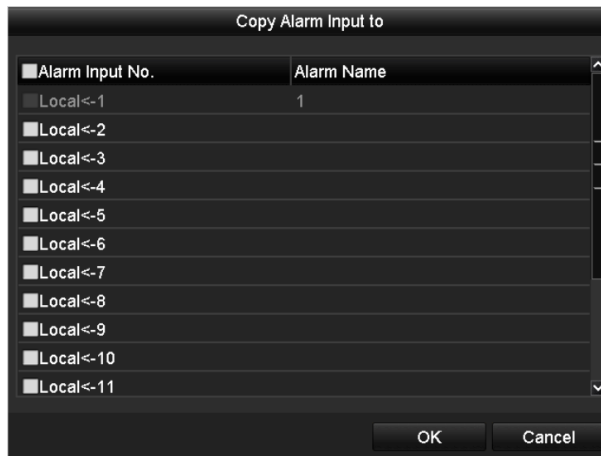

Figure 5. 18 Copy Alarm Input

3. Configure the schedule.

Please refer to the step 4 of *Chapter 5.2 Configuring Record Schedule*, while you may choose Alarm as the record type.

5.5 Configuring VCA Triggered Record

Purpose:

The DS-7200/7300/8100/9000 support the VCA (line crossing detection and intrusion detection) triggered recording.



- The VCA settings and VCA event triggered recording is supported by 1 analog camera for DS-7200/7300/8100HGHI models and 2 analog cameras for DS-7200/7300/8100/9000HQHI models.
- DS-7100-SH does not support VCA.

Steps:

1. Enter the VCA settings interface and select a camera for the VCA settings.

Menu> Camera> VCA

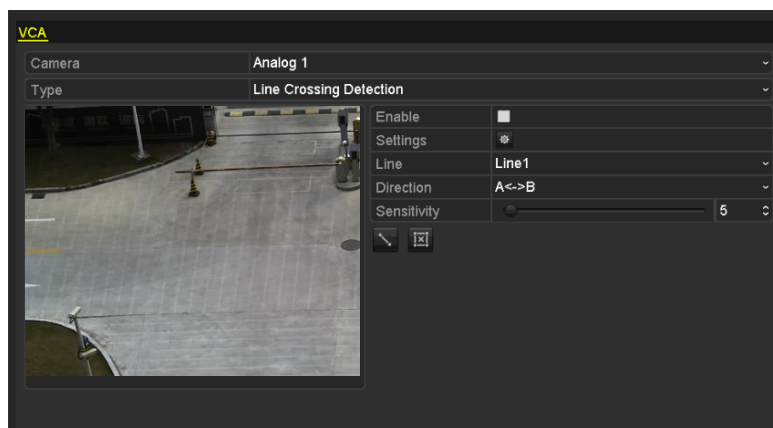



Figure 5. 19 VCA Settings

2. Configure the detection rules for VCA events. For details, see the step 2 in *Chapter 8.5 Detecting VCA Alarm*.
3. Click the icon  to configure the alarm linkage actions for the VCA events. Select **Trigger Channel** tab and select one or more channels which will start to record when VCA alarm is triggered.
Click **Apply** to save the settings

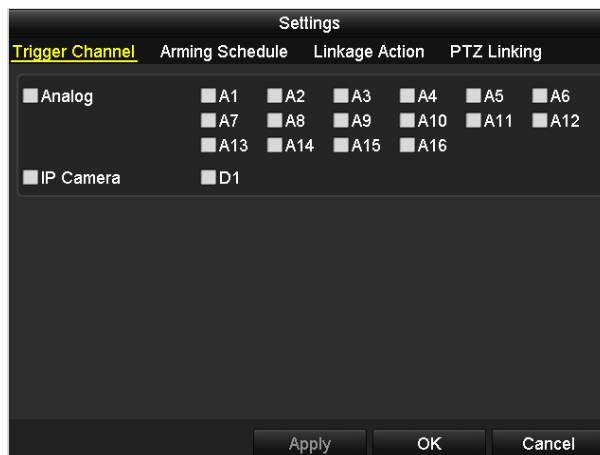

Figure 5. 20 Set Trigger Camera of VCA Alarm



The PTZ Linking function is only available for the VCA settings of IP cameras.

4. Enter Record Schedule settings interface (Menu> Record> Schedule>Record Schedule), and then set VCA as the record type. For details, see step 2 in *Chapter 5.2 Configuring Record Schedule*.

5.6 Configuring Manual Record

Purpose:

Follow the steps to set parameters for the manual record. Using manual record, you don't need to set a schedule for recording.

Steps:

1. Enter the Manual settings interface.

Menu > Manual

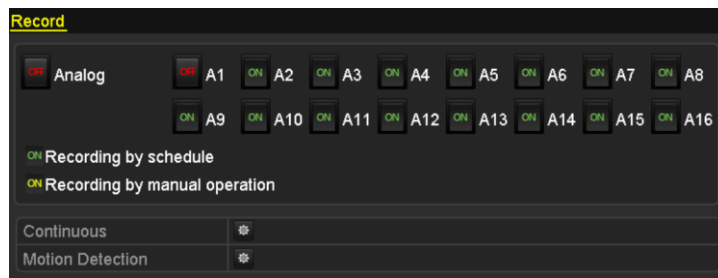

Figure 5. 21 Manual Record

2. Enable manual record.

Click the status icon **OFF** before camera number to change it to **ON**.

Or click the status icon **OFF** of **Analog** to enable manual record of all channels.

3. Disable manual record.

Click the status icon **ON** to change it to **OFF**.

Or click the status icon **ON** of **Analog** to disable manual record of all channels.



After rebooting all the manual records enabled are canceled.

5.7 Configuring Holiday Record

Purpose:

Follow the steps to configure the record schedule on holiday for that year. You may want to have different plan for recording on holiday.

Steps:

1. Enter the Record setting interface.

Menu>Record

2. Choose **Holiday** on the left bar.

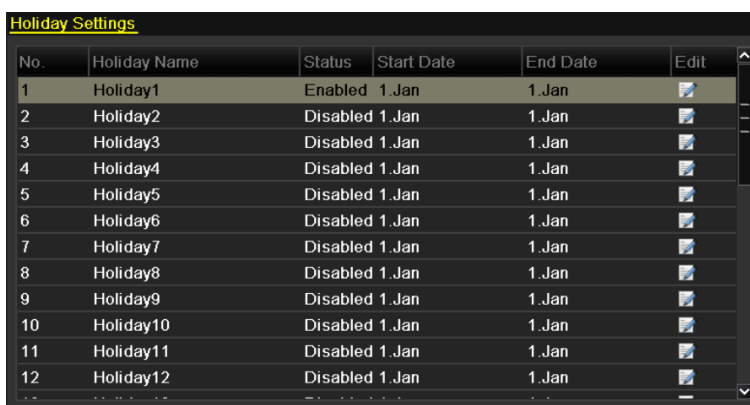

No.	Holiday Name	Status	Start Date	End Date	Edit
1	Holiday1	Enabled	1.Jan	1.Jan	
2	Holiday2	Disabled	1.Jan	1.Jan	
3	Holiday3	Disabled	1.Jan	1.Jan	
4	Holiday4	Disabled	1.Jan	1.Jan	
5	Holiday5	Disabled	1.Jan	1.Jan	
6	Holiday6	Disabled	1.Jan	1.Jan	
7	Holiday7	Disabled	1.Jan	1.Jan	
8	Holiday8	Disabled	1.Jan	1.Jan	
9	Holiday9	Disabled	1.Jan	1.Jan	
10	Holiday10	Disabled	1.Jan	1.Jan	
11	Holiday11	Disabled	1.Jan	1.Jan	
12	Holiday12	Disabled	1.Jan	1.Jan	

Figure 5.22 Holiday Settings

3. Enable Edit Holiday schedule.

- 1) Click  to enter the Edit interface.

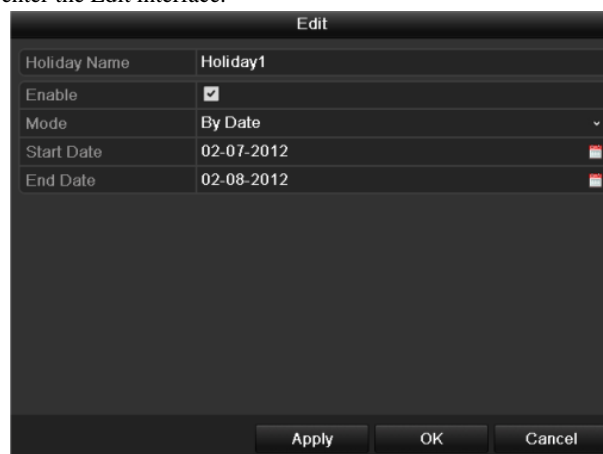

Edit	
Holiday Name	Holiday1
Enable	<input checked="" type="checkbox"/>
Mode	By Date
Start Date	02-07-2012
End Date	02-08-2012
<input type="button" value="Apply"/> <input type="button" value="OK"/> <input type="button" value="Cancel"/>	

Figure 5.23 Edit Holiday Settings

- 2) Check the checkbox of **Enable**.
- 3) Select Mode from the dropdown list.
There are three different modes for the date format to configure holiday schedule. By Month, By Week, and By Date are selectable.
- 4) Set the start and end date.
- 5) Click **Apply** to save settings.
- 6) Click **OK** to exit the Edit interface.

4. Configure the record schedule.

Please refer to the *Chapter 5.2 Configuring Record Schedule*, while you may choose Holiday in the Schedule dropdown list, or you can draw the schedule on the timeline of Holiday.

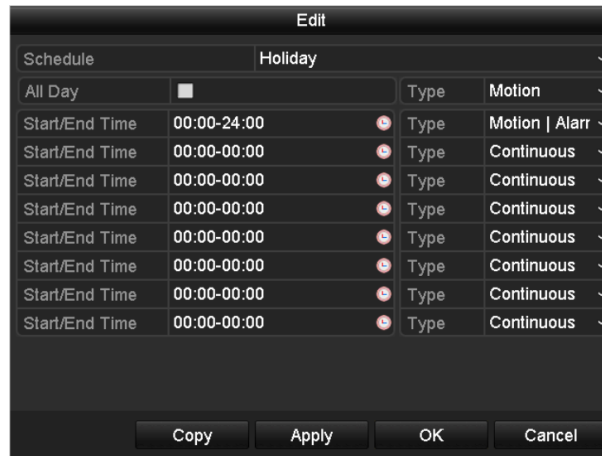

Figure 5. 24 Edit Schedule- Holiday

Up to 8 periods can be configured for each day. And the time periods cannot be overlapped each other.

In the time table of the channel, both holiday schedule and normal day schedule are displayed.

Repeat the above step 4 to set Holiday schedule for other channel. If the holiday schedule can also be used to other channels, click **Copy** and choose the channel you want to apply the settings.

5.8 Configuring Redundant Recording

Purpose:

Enabling redundant recording, which means saving the record files not only in the R/W HDD but also in the redundant HDD, will effectively enhance the data safety and reliability.

Before you start:

You must set the Storage mode in the HDD advanced settings to Group before you set the HDD property to Redundant. For detailed information, please refer to *Chapter 10.4 Managing HDD Group*. There should be at least another HDD which is in Read/Write status.

Steps:

1. Enter HDD Information interface.

Menu> HDD

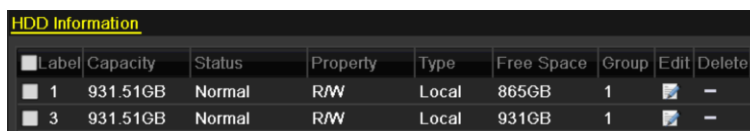

Label	Capacity	Status	Property	Type	Free Space	Group	Edit	Delete
1	931.51GB	Normal	R/W	Local	865GB	1		—
3	931.51GB	Normal	R/W	Local	931GB	1		—

Figure 5.25 HDD General

2. Select the **HDD** and click  to enter the Local HDD Settings interface.

- 1) Set the HDD property to Redundant.



Local HDD Settings

HDD No. 1

HDD Property

R/W

Read-only

Redundancy

Group

1 2 3 4 5 6 7 8

9 10 11 12 13 14 15 16

HDD Capacity 931.51GB

Apply OK Cancel

Figure 5.26 HDD General-Editing

- 2) Click **Apply** to save the settings.
 - 3) Click **OK** to back to the upper level menu.
3. Enter the Record setting interface.

Menu> Record> Parameters

- 1) Select the **Record** tab.

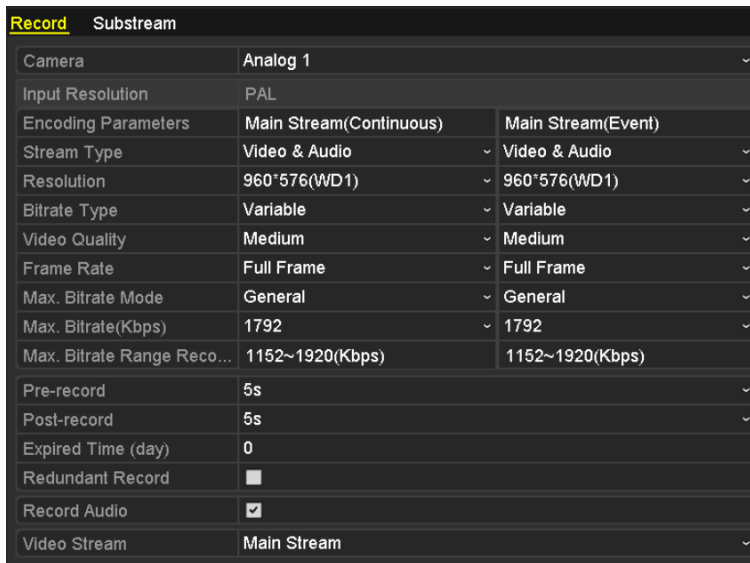

Figure 5. 27 Encoding Parameters

- 2) Select Camera you want to configure.
- 3) Check the checkbox of **Redundant Record**.
- 4) Click **Apply** to save settings.

If the encoding parameters can also be used to other channels, click **Copy** and choose the channel you want to apply the settings.

5.9 Configuring HDD Group for Recording

Purpose:

You can group the HDDs and save the record files in certain HDD group.

Steps:

1. Enter HDD setting interface.
Menu>HDD>Advanced
2. Select **Advanced** on the left bar.
Check whether the storage mode of the HDD is Group. If not, set it to Group. For detailed information, please refer to *Chapter 10.4 Managing HDD Group*.
3. Select **General** in the left bar.
Click  to enter editing interface.
4. Configuring HDD group.
 - 1) Choose a group number for the HDD group.
 - 2) Click **Apply** to save your settings.
 - 3) Click **OK** to back to the upper level menu.Repeat the above steps to configure more HDD groups.
5. Choose the Channels which you want to save the record files in the HDD group.
 - 1) Select **Advanced** on the left bar.

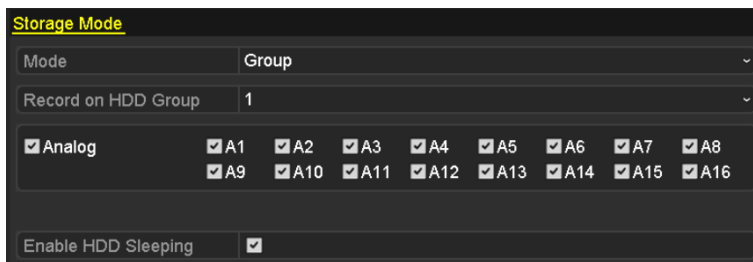

Figure 5. 28 HDD Advanced

- 2) Choose Group number in the dropdown list of **Record on HDD Group**
- 3) Check the channels you want to save in this group.
- 4) Click **Apply** to save settings.

After you have configured the HDD groups, you can configure the Recording settings following the procedure provided in *Chapter 5.2-5.7*.

5.10 Files Protection

Purpose:

You can lock the recorded files or set the HDD property to Read-only to protect the record files from being overwritten.

Protect file by locking the record files

Steps:

1. Enter Playback setting interface.

Menu> Export

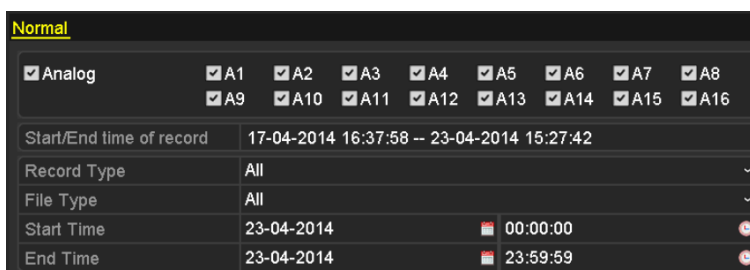



Figure 5.29 Export

2. Select the channels you want to investigate by checking the checkbox to .
3. Configure the record type, file type, start time and end time.
4. Click **Search** to show the results.





Figure 5.30 Export- Search Result

5. Protect the record files.

- 1) Find the record files you want to protect, and then click the  icon which will turn to , indicating that the file is locked.



The record files of which the recording is still not completed cannot be locked.

- 2) Click  to change it to  to unlock the file and the file is not protected.

Protect file by setting HDD property to Read-only

Before you start:

To edit HDD property, you need to set the storage mode of the HDD to Group. See *Chapter 10.4 Managing HDD Group*.

Steps:

1. Enter HDD setting interface.

Menu> HDD

HDD Information								
<input type="checkbox"/> Label	Capacity	Status	Property	Type	Free Space	Group	Edit	Delete
<input type="checkbox"/> 1	931.51GB	Normal	R/W	Local	865GB	1		—
<input type="checkbox"/> 3	931.51GB	Normal	R/W	Local	931GB	1		—

Figure 5. 31 HDD General

2. Click to edit the HDD you want to protect.

Local HDD Settings

HDD No.

HDD Property

R/W

Read-only

Redundancy

Group 1 2 3 4 5 6 7 8

9 10 11 12 13 14 15 16

HDD Capacity

Figure 5. 32 HDD General- Editing

3. Set the HDD to Read-only.
4. Click **OK** to save settings and back to the upper level menu.

- You cannot save any files in a Read-only HDD. If you want to save files in the HDD, change the property to R/W.
- If there is only one HDD and is set to Read-only, the DVR cannot record any files. Only live view mode is available.
- If you set the HDD to Read-only when the DVR is saving files in it, then the file will be saved in next R/W HDD. If there is only one HDD, the recording will be stopped.

Chapter 6 Playback

6.1 Playing Back Record Files

6.1.1 Instant Playback

Purpose:

Play back the recorded video files of a specific channel in the live view mode. Channel switch is supported.

Instant playback by channel

Steps:

Choose a channel in live view mode and click the  button in the quick setting toolbar.



In the instant playback mode, only record files recorded during the last five minutes on this channel will be played back.



Figure 6. 1 Instant Playback Interface

6.1.2 Playing Back by Normal Search

Playback by Channel

Enter the Playback interface.

Mouse: right click a channel in live view mode and select Playback from the menu, as shown in the following figure:

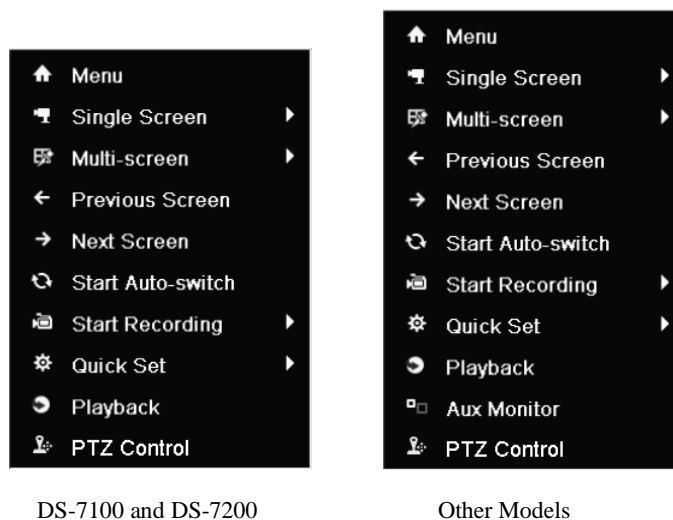

Figure 6. 2 Right-click Menu under Live View

The DS-7100, DS-7200, and DS-7324/7332HGHI-SH provide no Aux Monitor option.

Front Panel: press **PLAY** button to play back recording files of the channel under single-screen live view mode.

Under multi-screen live view mode, the recorded files of the top-left channel will be played back.

For the DS-7300/8100/9000, pressing numerical buttons will switch playback to the corresponding camera during playback process.

Playback by Time

Purpose:

Play back video files recorded in specified time duration. Multi-channel simultaneous playback and channel switch are supported.



Steps:

1. Enter playback interface.
Menu>Playback
2. Check the checkbox of channel(s) in the channel list and then double-click to select a date on the calendar.



Figure 6. 3 Playback Calendar



If there are record files for that camera in that day, in the calendar, the icon for that day is displayed as . Otherwise it is displayed as .

Playback Interface

You can use the toolbar in the bottom part of Playback interface to control playing progress, as shown in the following figure.

















Figure 6. 4 Playback Interface







Click the channel(s) if you want to switch playback to another channel or execute simultaneous playback of multiple channels.





Figure 6. 5 Toolbar of Playback

Table 6. 1 Detailed Explanation of Playback Toolbar

Button	Operation	Button	Operation	Button	Operation
	Mute/Audio on		Start/Stop clipping		Save clip(s)
	Add default tag		Add customized tag		Tag management
	Digital Zoom		Pause/ Play Reverse		Stop
	30s backward		30s forward		Previous day
	Slow forward		Fast forward		Next day

	Scaling up/down time bar		Process bar		Full Screen
	Exit		Video type bar		Normal playback
	Adjust the audio volume				

- The **15-08-2014 05:32:49 -- 02-04-2015 09:56:47** indicates the start time and end time of the record files.
-  represents normal recording (manual or schedule);  represents event recording (motion, alarm, motion | alarm, motion & alarm).
- Playback progress bar: use the mouse to click any point of the progress bar to locate special frames.

6.1.3 Playing Back by Event Search



Purpose:

Play back record files on one or several channels searched out by restricting event type (motion detection, alarm input or VCA). Channel switch is supported.



- Playback by alarm input search is not supported by DS-7100 and DS-7200HGHI series DVR.
- DS-7100 does not support VCA type.

Steps:

1. Enter the playback interface.
Menu>Playback
2. Click  and select  to enter the Event Playback interface.
3. Select **Alarm Input, Motion, Line Crossing Detection, Intrusion Detection** as the event type, and specify the start time and end time for search.

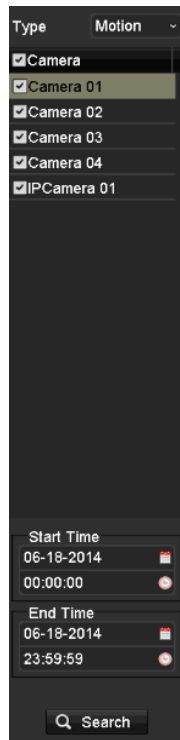



Figure 6. 6 Video Search by Motion Detection

4. Click **Search**, and the record files matching the search conditions will be displayed on a list.

5. Select and click  button to play back the record files.

You can click **Back** to return to the search interface.

If there is only one channel triggered, clicking  button takes you to Full-screen Playback interface of this channel.

If several channels are triggered, clicking  button takes you to the synch playback interface. Check checkbox to select one channel for playback or select multiple channels for synchronous playback.



The max. number of channels for synchronous playback supported varies to different models.

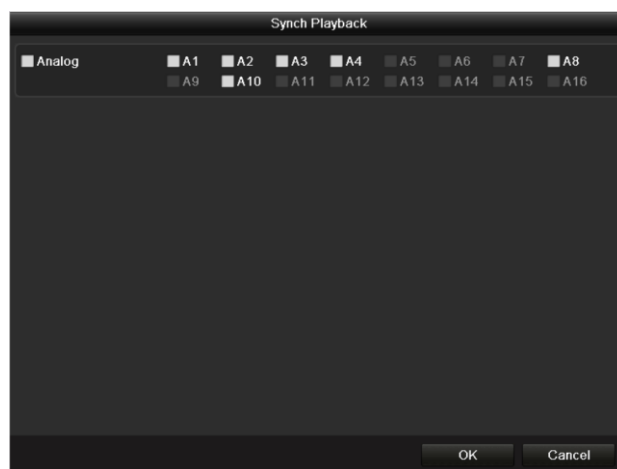

Figure 6. 7 Select Channels for Synchronous Playback

6. Event playback interface.

The toolbar in the bottom part of Playback interface can be used to control playing process.



Figure 6. 8 Interface of Playback by Event

Pre-play and post-play can be configured for the playback of event triggered record files.

Pre-play: The time you set to play back before the event. For example, when an alarm triggered the recording at 10:00, if you set the pre-play time as 5 seconds, the video plays back from 9:59:55.

Post-play: The time you set to play back after the event. For example, when an alarm triggered the recording ends at 11:00, if you set the post-play time as 5 seconds, the video plays back till 11:00:05.

7. You can click ◀ or ▶ button to select the previous or next event. Please refer to Table 6.1 for the description of buttons on the toolbar.

6.1.4 Playing Back by Tag

Purpose:



Video tag allows you to record related information like people and location of a certain time point during playback. You are also allowed to use video tag(s) to search for record files and position time point.

Before playing back by tag:

1. Enter Playback interface.
Menu>Playback
2. Search and play back the record file(s). Refer to *Chapter 6.1.2 Playing Back by Channel* for the detailed information about searching and playback of the record files.



Figure 6.9 Interface of Playback by Time

- Click  button to add default tag.
- Click  button to add customized tag and input tag name.



Max. 64 tags can be added to a single video file.

3. Tag management.

- Click  button to check, edit and delete tag(s).



Figure 6.10 Tag Management Interface

Steps:

1. Select the **Tag** from the drop-down list in the Playback interface.
2. Choose channels, edit start time and end time, and then click Search to enter Search Result interface.



You can enter keyword in the textbox to search the tag on your command.





Figure 6.11 Video Search by Tag

3. Click  button to play back the file.

You can click the **Back** button to back to the search interface.



Pre-play and post-play can be configured.

You can click  or  button to select the previous or next tag. Please refer to Table 6.1 for the description of buttons on the toolbar.

6.1.5 Playing Back by Smart Search



Purpose:

The smart playback function provides an easy way to get through the less effective information. When you select the smart playback mode, the system will analyze the video containing motion or VCA information, and mark it with green color on the playback process bar. The filtering rule of record files and playback speed for the non-related and related video can be configured on your demand.



The playback by smart search is not supported for IP cameras.

Steps:

1. Enter the Smart Playback interface.
2. Select a camera in the camera list and select a date in the calendar and click the  button to play.
3. Click the  on the toolbar to enter Smart Search mode. The smart search toolbar appears at the bottom of the screen.

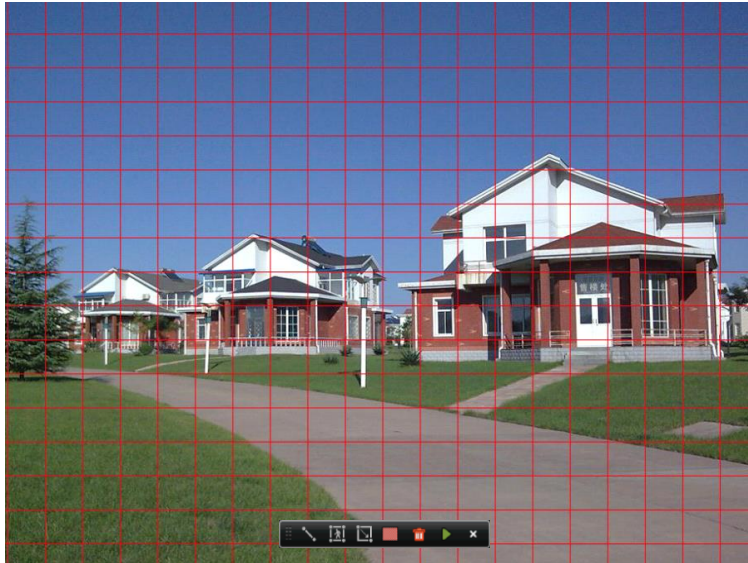



Figure 6.12 Draw Area for Smart Search



The VCA event is not supported by DS-7100 series.

4. Click and drag the mouse to draw area(s) for smart search of VCA event or motion event.



- **Line Crossing Detection**



Click the  button, and click on the video display screen to specify the start point and end point of the line.

- **Intrusion Detection**

Click the  button, and specify 4 points to set a quadrilateral region for intrusion detection. Only one region can be set.

- **Motion Detection**

Click the  button and then click and draw the mouse to set the detection area manually. You can also click the  button to set the full screen as the detection area.

5. Click the  to search, and then the result will be displayed as  in the progress bar of the Smart Playback interface.

Or you can click the  button to clear all the set areas.

6. Click the  button to play

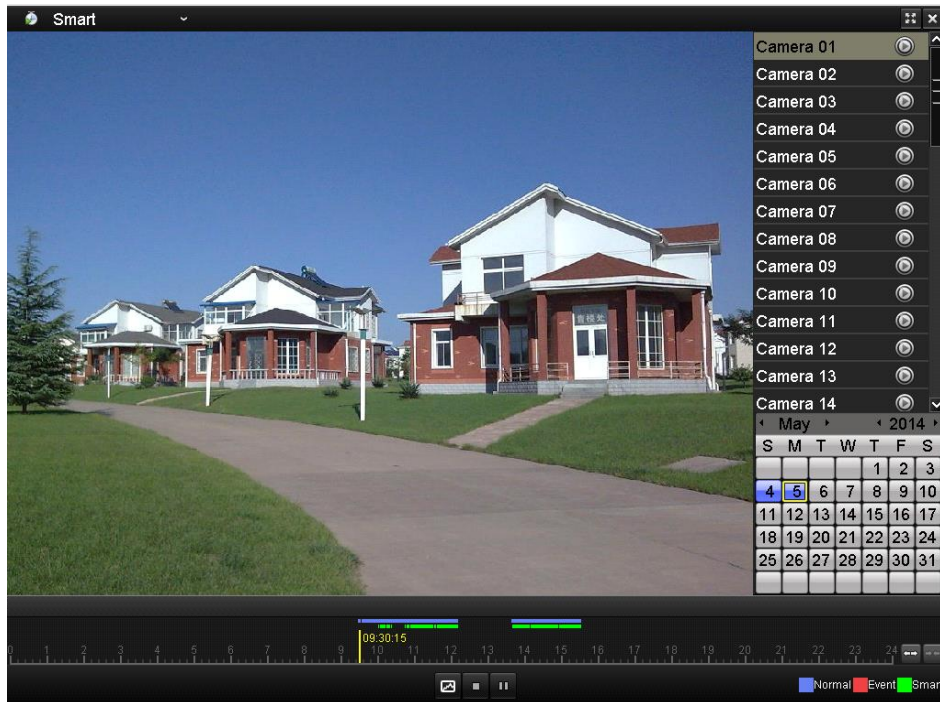

Figure 6.13 Smart Playback Interface



- Playback progress bar: use the mouse to click any point of the progress bar or drag the progress bar to locate special frames.
- About video type bar: ■ represents normal recording (manual or schedule); ■ represents event recording; ■ represents smart search recording.

Table 6.2 Detailed Explanation of Smart Playback

Button	Operation	Button	Operation	Button	Operation
	Smart search		Stop		Pause play/ Play
	Process bar		Scaling up/down the time line		Video type / picture

6.1.6 Playing Back by System Logs

Purpose:

Play back record file(s) associated with channels after searching system logs.

Steps:

1. Enter Log Information interface.
Menu>Maintenance>Log Information

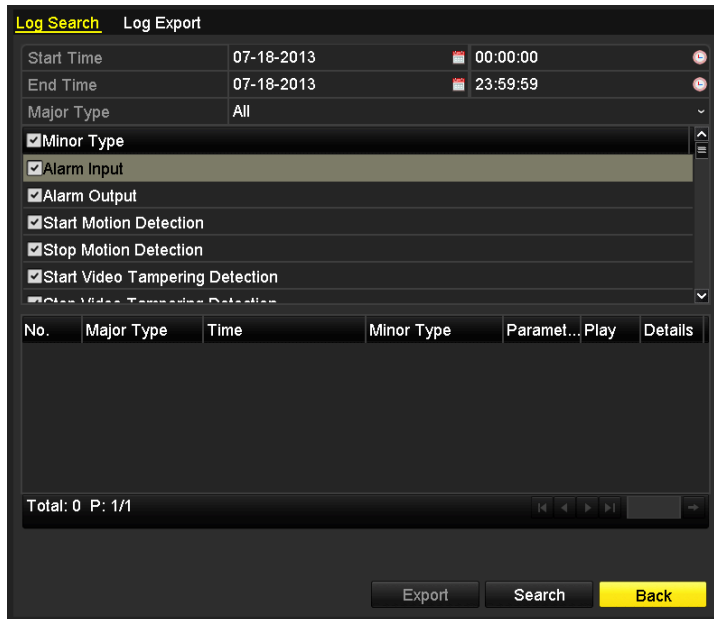

Figure 6. 14 System Log Search Interface

2. Click **Log Search** tab to enter Playback by System Logs.
Set search time and type and click **Search** button.

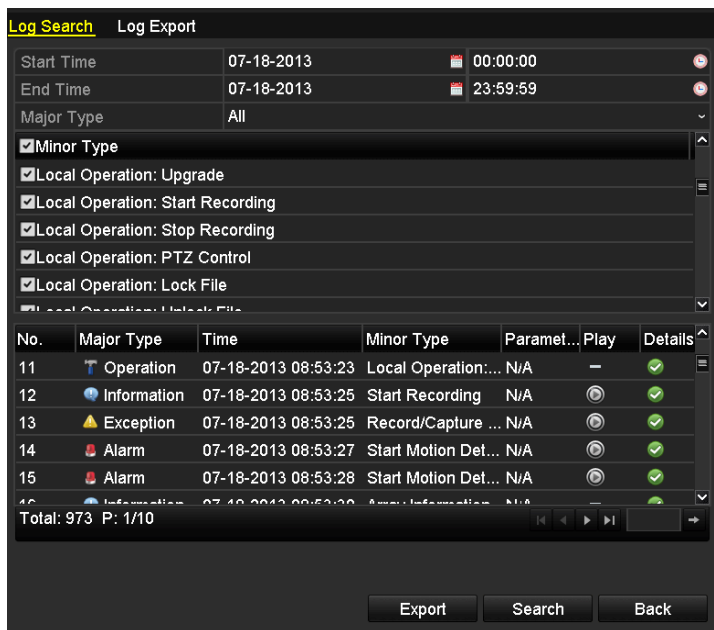

Figure 6. 15 Result of System Log Search

3. Choose a log with record file and click  button to enter Playback interface.



If there is no record file at the time point of the log, the message box “No result found” will pop up.

4. Playback management.
The toolbar in the bottom part of Playback interface can be used to control playing process.





Figure 6. 16 Interface of Playback by Log

6.1.7 Playing Back External File

Purpose:

Perform the following steps to look up and play back files in the external devices.

Steps:

1. Enter the Playback interface.
Menu>Playback
2. Select the **External File** in the drop-down list on the top-left side.
The files are listed in the right-side list.
You can click the  Refresh button to refresh the file list.
3. Select and click the  button to play back it.

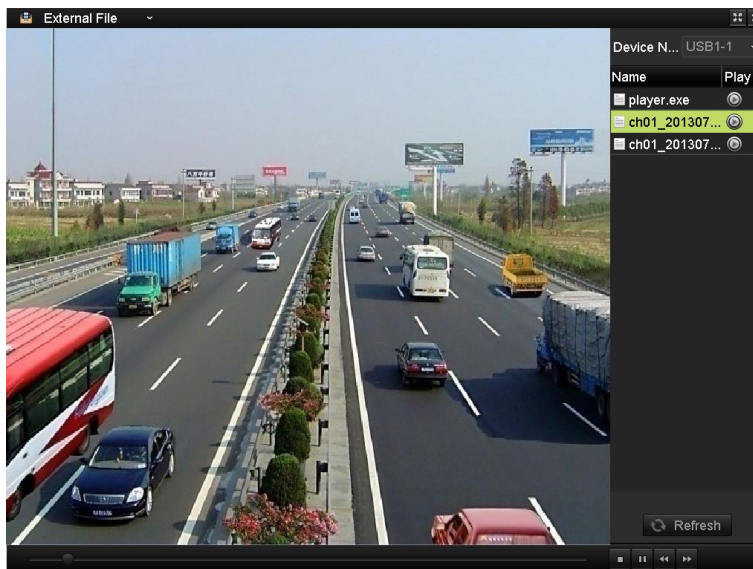

Figure 6. 17 Interface of External File Playback

6.2 Auxiliary Functions of Playback



6.2.8 Playing Back Frame by Frame

Purpose:



Play video files frame by frame, in order to check image details of the video when abnormal events happen.

Steps:

- **Using a Mouse**

Go to Playback interface and click button  until the speed changes to *Single* frame. One click on the playback screen represents playback or adverse playback of one frame. It is also feasible to use button  in toolbar.

- **Using the front panel (Not supported by DS-7100-SH and DS-7200HGHI-SH)**

Press the  button to set the speed to *Single* frame. One click on the playback screen or press  button on the front panel represents playback or adverse playback of one frame.

6.2.9 Digital Zoom

Steps:

1. Click the  button on the playback control bar to enter Digital Zoom interface.
2. Use the mouse to draw a red rectangle and the image within it will be enlarged up to 16 times.



Figure 6.18 Draw Area for Digital Zoom

3. Right-click the image to exit the digital zoom interface.

6.2.10 Reverse Playback of Multi-channel

Purpose:

You can play back record files of multi-channel reversely. Up to 16-ch simultaneous reverse playback is

supported.

Steps:

1. Enter Playback interface.
Menu>Playback
2. Check more than one checkboxes to select multiple channels and click to select a date on the calendar.



Figure 6. 19 4-ch Synchronous Playback Interface

3. Click  to play back the record files reversely.

Chapter 7 Backup

7.1 Backing up Record Files

Before you start:

Please insert the backup device(s) into the device.

7.1.1 Backing up by Normal Video Search

Purpose:

The record files can be backed up to various USB devices, such as USB flash drives, USB HDDs, and USB writer.

Backup using USB flash drives, USB HDDs, and USB writer

Steps:

1. Enter Export interface.
Menu>Export>Normal

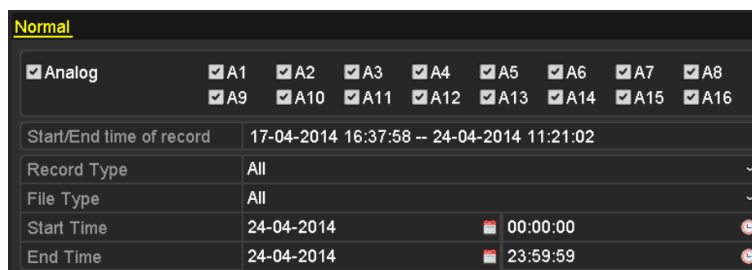

Figure 7. 1 Normal Export Interface

2. Set search condition and click **Search** button to enter the search result interface.

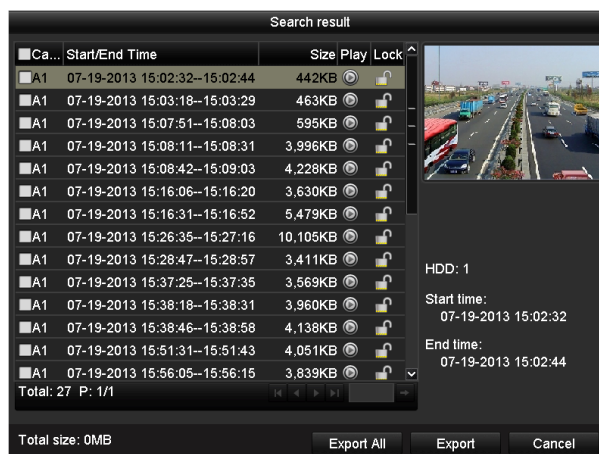



Figure 7. 2 Result of Normal Video Search for Backup

3. Select record files you want to back up.

Click button  to play the record file if you want to check it.
Check the checkbox before the record files you want to back up.



The size of the currently selected files is displayed in the lower-left corner of the window.

4. Export.

Click **Export** button and start backup.



If the inserted USB device is not recognized:

- Click the **Refresh** button.
- Reconnect device.
- Check for compatibility from vendor.

You can also format the USB device by clicking the **Format** button.



Figure 7.3 Export by Normal Video Search using USB Flash Drive

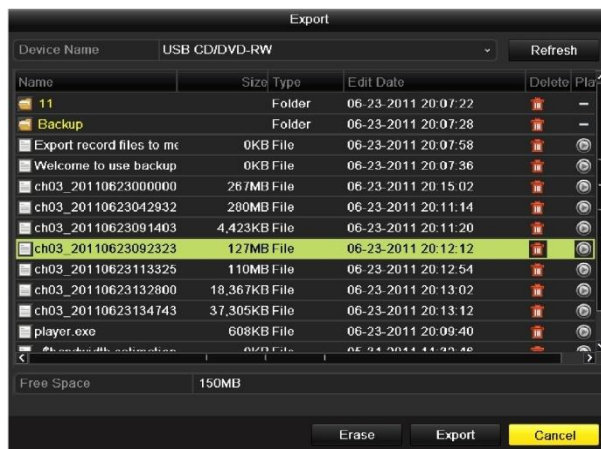

Figure 7.4 Export by Normal Video Search using USB Writer

Stay in the Exporting interface until all record files are exported with pop-up message box “Export finished”.

5. Check backup result.

Choose the record file in Export interface and click [Play] button to check it.



The Player player.exe will be exported automatically during record file export.

Backup using eSATA HDDs



This function is supported by DS-7300/8100/9000 series DVR.

Steps:

1. Enter Record>Advanced and set the usage of eSATA HDD at “Export”.

Menu>Record>Advanced

Choose eSATA and set its usage at Export. Click **Yes** when pop-up message box “System will reboot automatically if the usage of eSATA is changed. Continue?”



The usages of eSATA HDD contain Record and Export. And changes in usage will take effective after rebooting the device.

2. Enter Export interface.

Menu>Export>Normal

Set search condition and click **Search** button to enter the search result interface.

3. Select record files you want to back up.

Click button to play the record file if you want to check it.

Tick record files you want to back up.



The size of the currently selected files is displayed in the lower-left corner of the window.

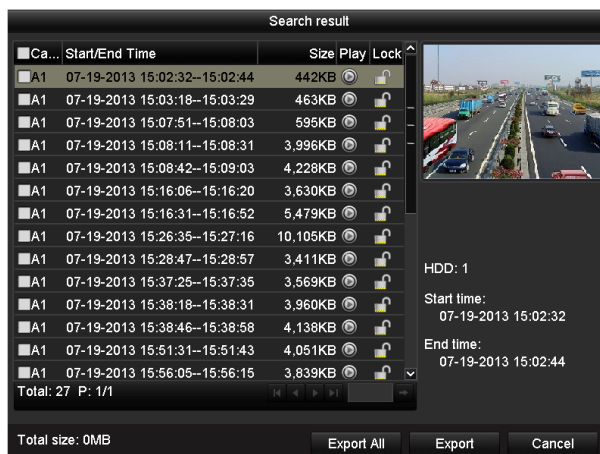

Figure 7. 5 Result of Normal Video Search for Backup

4. Export.

Click **Export** button and start backup.



- Please format the eSATA first when using it for the first time.
- If the inserted eSATA HDD is not recognized:
 - Click the **Refresh** button.
 - Reconnect device.
 - Check for compatibility from vendor.

You can also format eSATA HDD via the device.

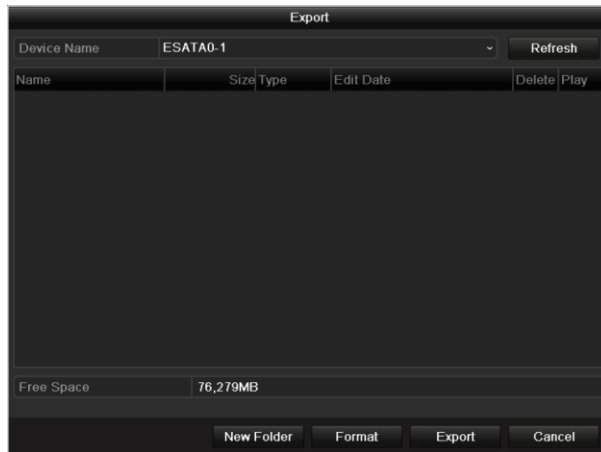

Figure 7. 6 Export by Normal Video Search Using eSATA HDD

Stay in the Exporting interface until all record files are exported with pop-up message “Export finished”.

5. Check backup result.

Choose the record file in Export interface and click button  to check it.



The Player player.exe will be exported automatically during record file export.

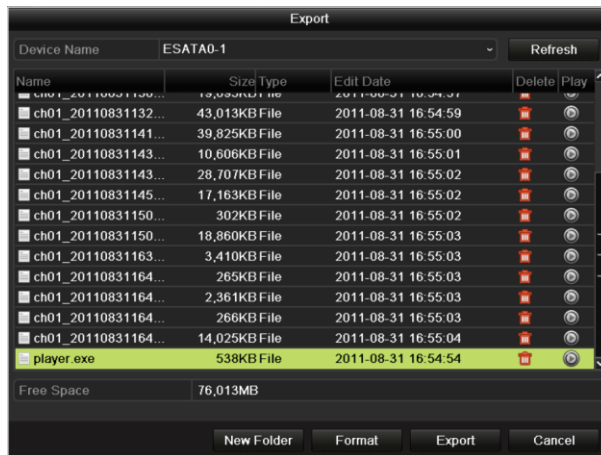

Figure 7. 7 Checkup of Export Result Using eSATA HDD

7.1.2 Backing up by Event Search

Purpose:

Back up event-related recording files using USB devices, such as USB flash drives, USB HDDs, and USB writer.

Steps:

1. Enter Export interface.
Menu>Export>Event
2. Search for events.
 - 1) Select **Motion**, **Alarm Input**, **Line Crossing Detection** or **Intrusion Detection** as the event type.



- Here we take the backup by motion detection as the example.
 - Backup by alarm input is not supported by DS-7100 and DS-7200HGHI series DVR.
 - Backup by VCA (Line Crossing Detection, Intrusion Detection) search is not supported by DS-7100.
- 2) Check the checkbox of cameras and set the search time.
 - 3) Click **Search** button to enter the Search Result interface.

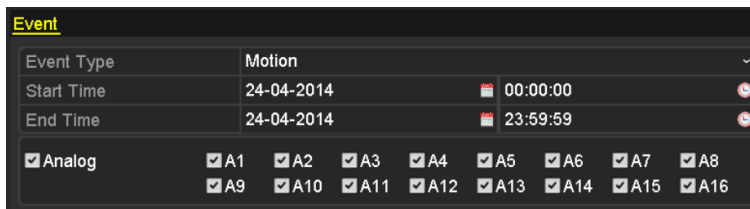

Figure 7. 8 Event Search for Backup

3. Select record files to export.

- 1) Select an alarm input in the list and click **Quick Export** button to enter Export interface.
- 2) Clicking **Details** button will take you to the interface with detailed information of all channels triggered by the event.

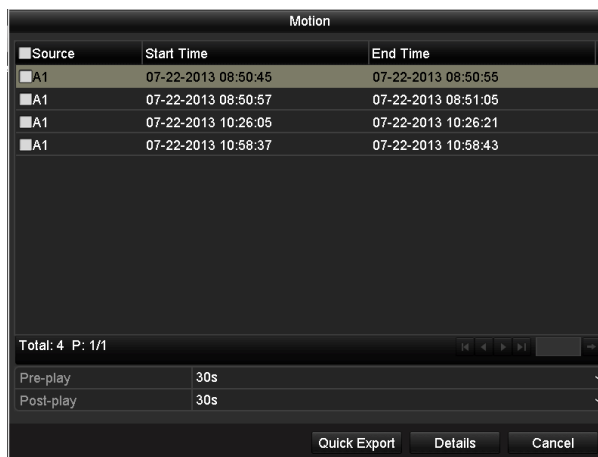

Figure 7. 9 Result of Event Search

- 3) Click **Details** button to view detailed information of the record file, e.g. start time, end time, file size, etc.



The size of the currently selected files is displayed in the lower-right corner of the window.

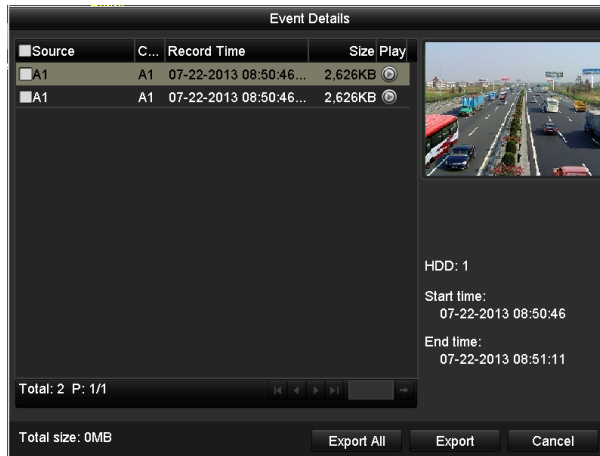

Figure 7. 10 Event Details Interface

4. Export.

Click the **Export** button and start backing up.



If the inserted USB device is not recognized:

- Click the Refresh button.
- Reconnect device.
- Check for compatibility from vendor.

You can also format USB flash drive or USB HDDs via the device.



Figure 7. 11 Export by Event Using USB Flash Drive

Stay in the Exporting interface until all record files are exported with pop-up message “Export finished”.

5. Check backup result.



The Player player.exe will be exported automatically during record file export.



Figure 7. 12 Checkup of Event Export Result Using USB Flash Drive

7.1.3 Backing up Video Clips

Purpose:

You may also select video clips to export directly during Playback, using USB devices, such as USB flash drives, USB HDDs, and USB writers.

Steps:

1. Enter Playback interface.

Please refer to *Chapter 6 Playback*.



Figure 7. 13 Interface of Playback



2. During playback, use buttons  and  in the playback toolbar to start and stop clipping record file(s).
3. Click the icon  to enter the Clips Export interface.



Figure 7. 14 Clips Export



Up to 30 items of video clips can be selected for backup at one time.

4. Click the button **Export** to export the selected video clips to the backup device.



If the inserted USB device is not recognized:

- Click the **Refresh** button.
- Reconnect device.
- Check for compatibility from vendor.

You can also format USB devices by clicking the **Format** button.



Figure 7. 15 Export Video Clips Using USB Flash Drive

Stay in the Exporting interface until all record files are exported with pop-up message “Export finished”.

5. Or a prompt will pop up when you quit the Playback interface if there are clips not saved.

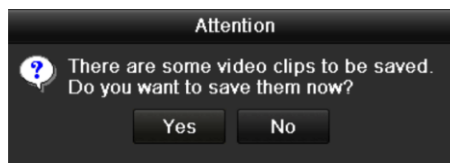

Figure 7. 16 Attention to Video Clip Saving

6. Click **Yes** to save video clips and enter Export interface, or click **No** to quit without saving video clips.
7. Check backup result.

The Player player.exe will be exported automatically during record file export.

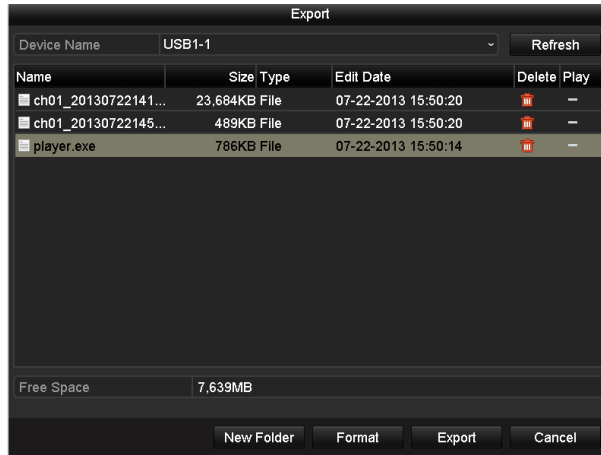

Figure 7.17 Checkup of Video Clips Export Result Using USB Flash Drive

7.2 Managing Backup Devices

Steps:

1. Enter Search Result interface of record files.

Menu>Export>Normal

Set search condition and click **Search** button to enter Search Result interface.



At least one channel shall be selected.

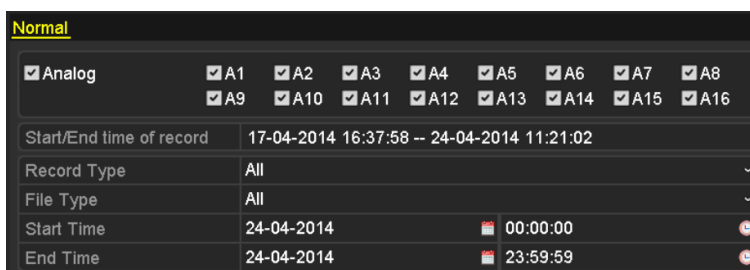

Figure 7. 18 Normal Video Search for Backup

2. Select record files you want to back up.

Click **Export** button to enter Export interface.



At least one recording file shall be selected.



Figure 7. 19 Result of Normal Video Search for Backup

3. Backup device management.

➤ Management of USB flash drives, USB HDDs and eSATA HDDs



Figure 7. 20 USB Flash Drive Management

Click **New Folder** button if you want to create a new folder in the backup device.

Select a record file or folder in the backup device and press button  if you want to delete it.

Select a record file in the backup device and press button  to play it.

Click **Format** button to format the backup device.

If the inserted USB device is not recognized:

- Click the **Refresh** button.
- Reconnect device.
- Check for compatibility from vendor.

➤ **Management of USB writers**

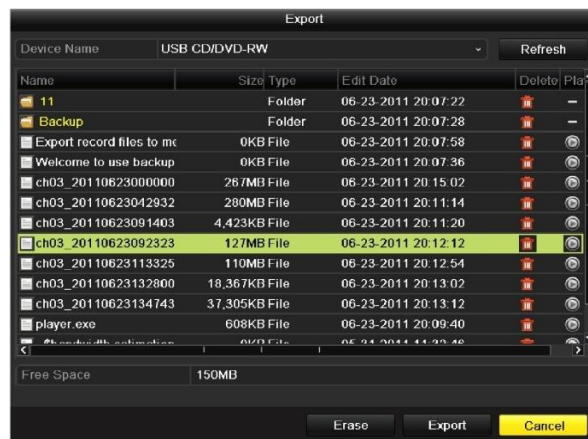

Figure 7. 21 USB Writer Management

Click **Erase** button if you want to erase the files from a re-writable CD/DVD.

- There must be a re-writable CD/DVD when you make this operation.
- If the inserted USB writer is not recognized:
 - Click the **Refresh** button.
 - Reconnect device.
 - Check for compatibility from vendor.

Chapter 8 Alarm Settings

8.1 Setting Motion Detection

Steps:

1. Enter Motion Detection interface of Camera Management and choose a camera you want to set up motion detection.

Menu > Camera > Motion



Figure 8.1 Motion Detection Setup Interface

2. Set detection area and sensitivity.

Check checkbox to enable motion detection, use the mouse to draw detection area(s) and drag the sensitivity bar to set sensitivity.

Click  to set alarm response actions.

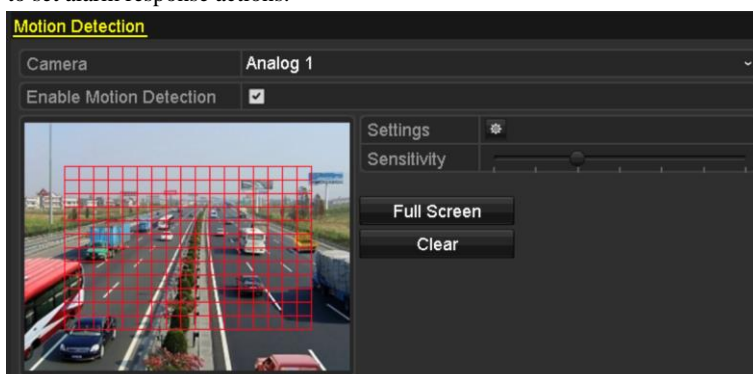

Figure 8.2 Set Detection Area and Sensitivity

3. Click **Trigger Channel** tab and select one or more channels which will start to record or become full-screen monitoring when motion alarm is triggered.

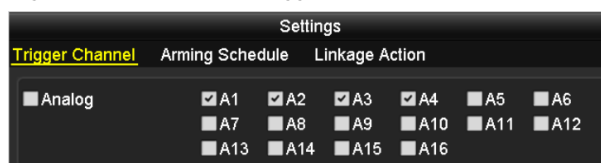

Figure 8.3 Set Trigger Camera of Motion Detection

4. Set arming schedule of the channel.

Select **Arming Schedule** tab to set the channel's arming schedule.

Choose one day of a week and up to eight time periods can be set within each day. Or you can click the **Copy** button to copy the time period settings to other day(s).



Time periods shall not be repeated or overlapped.



Figure 8.4 Set Arming Schedule of Motion Detection

5. Click **Linkage Action** tab to set up alarm response actions of motion alarm (please refer to *Chapter 8.8 Setting Alarm Response Actions*).
Repeat the above steps to set up arming schedule of other days of a week.
Click the **OK** button to complete the motion detection settings of the channel.
6. If you want to set motion detection for another channel, repeat the above steps or just copy the above settings to it.



You are not allowed to copy the “Trigger Channel” action.

8.2 Setting Sensor Alarms



This function is not supported by DS-7100 and DS-7200HGHI series DVR.

Purpose:

Set up handling method of an external sensor alarm.

Steps:

1. Enter Alarm Settings of System Configuration and select an alarm input.

Menu> Configuration> Alarm

Select Alarm Input tab to enter Alarm Input Settings interface.

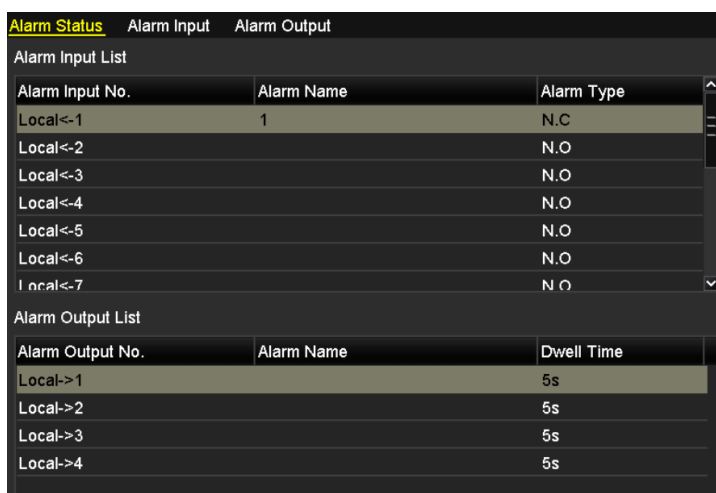

Figure 8. 5 Alarm Status Interface of System Configuration

2. Set the handling method of the selected alarm input.

Check the **Setting** checkbox and click button to set its alarm response actions.

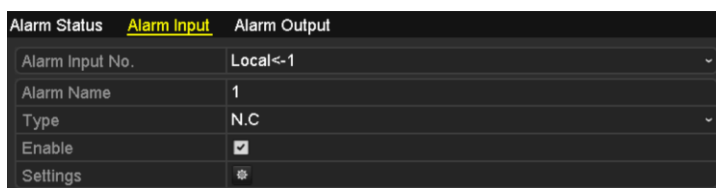

Figure 8. 6 Alarm Input Settings Interface

3. Select Trigger Channel tab and select one or more channels which will start to record or become full-screen monitoring when an external alarm input is triggered.
4. Select **Arming Schedule** tab to set the channel's arming schedule.
Choose one day of a week and Max. eight time periods can be set within each day.

Time periods shall not be repeated or overlapped.

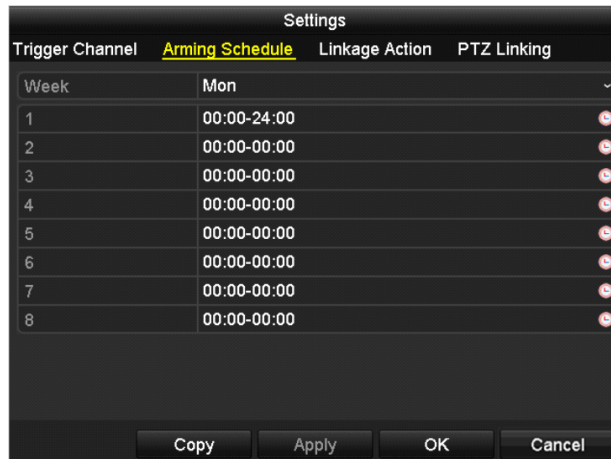

Figure 8.7 Set Arming Schedule of Alarm Input

5. Select **Linkage Action** tab to set up alarm response actions of the alarm input (please refer to *Chapter 8.8 Setting Alarm Response Actions*).

Repeat the above steps to set up arming schedule of other days of a week. You can also use **Copy** button to copy an arming schedule to other days.

6. If necessary, select **PTZ Linking** tab and set PTZ linkage of the alarm input.

Set PTZ linking parameters and click the **OK** button to complete the settings of the alarm input.

Please check whether the PTZ or speed dome supports PTZ linkage.

One alarm input can trigger presets, patrol or pattern of more than one channel. But presets, patrols and patterns are exclusive.

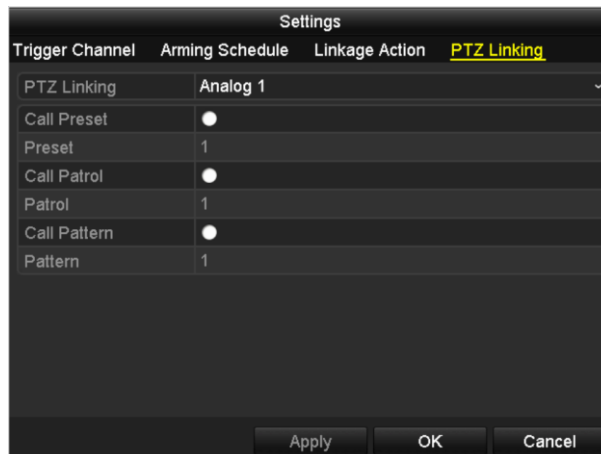

Figure 8.8 Set PTZ Linking of Alarm Input

7. If you want to set handling action of another alarm input, repeat the above steps or just copy the above settings to it.

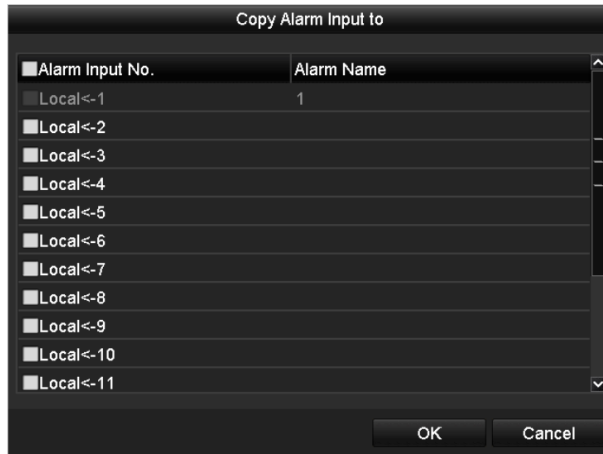

Figure 8. 9 Copy Settings of Alarm Input

8.3 Detecting Video Loss

Purpose:

Detect video loss of a channel and take alarm response action(s).

Steps:

1. Enter Video Loss interface of Camera Management and select a channel you want to detect.

Menu> Camera> Video Loss

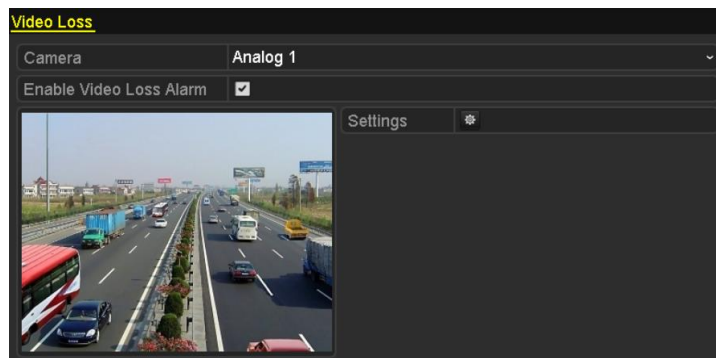



Figure 8.10 Video Loss Setup Interface

2. Set up handling method of video loss.

Check the checkbox of “Enable Video Loss Alarm”.

Click  button to set up handling method of video loss.

3. Set arming schedule of the channel.

Select **Arming Schedule** tab to set the channel’s arming schedule.

Choose one day of a week and up to eight time periods can be set within each day. Or you can click the

Copy button to copy the time period settings to other day(s).



Time periods shall not be repeated or overlapped.

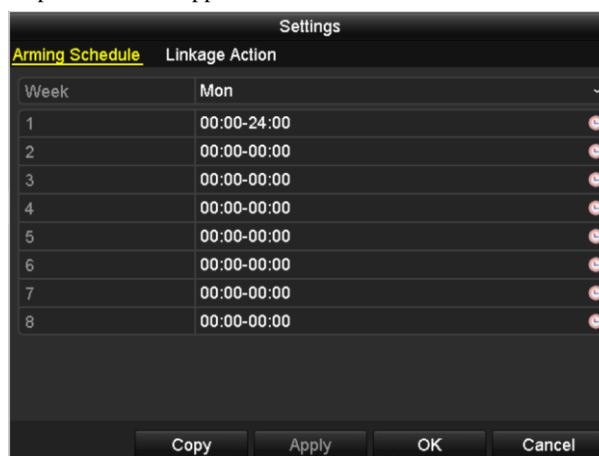

Figure 8.11 Set Arming Schedule of Video Loss

Repeat the above steps to set arming schedule of other days of a week. You can also use **Copy** button to copy an arming schedule to other days.

4. Select **Linkage Action** tab to set up alarm response action of video loss (please refer to *Chapter 8.8 Setting Alarm Response Actions*).
5. Click the **OK** button to complete the video loss settings of the channel.
Repeat the above steps to finish settings of other channels, or click the **Copy** button copy the above settings to them.

8.4 Detecting Video Tampering

Purpose:

Trigger alarm when the lens is covered and take alarm response action(s).

Steps:

1. Enter Video Tampering interface of Camera Management and select a channel you want to detect video tampering.

Menu> Camera> Video Tampering Detection

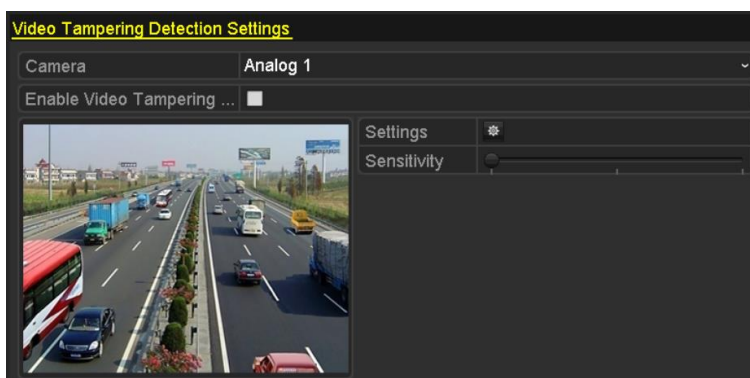



Figure 8.12 Video Tempering Interface

2. Check the checkbox of “Enable Video Tampering”.
3. Drag the sensitivity bar and choose a proper sensitivity level.
4. Click  to set handling method of video tampering. Set arming schedule and alarm response actions of the channel.
 - 1) Click **Arming Schedule** tab to set the arming schedule of response action.
 - 2) Choose one day of a week and up to eight time periods can be set within each day.

Time periods shall not be repeated or overlapped.

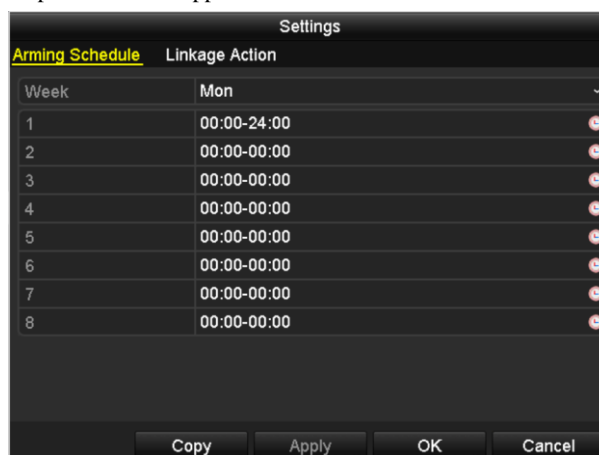

Figure 8.13 Set Arming Schedule of Video Tampering

- 3) Select **Linkage Action** tab to set alarm response actions of video tampering alarm (please refer to

Chapter 8.8 Setting Alarm Response Actions).

Repeat the above steps to set arming schedule of other days of a week. You can also use **Copy** button to copy an arming schedule to other days.

- 4) Click the **OK** button to complete the video tampering settings of the channel.

Repeat the above steps to finish settings of other channels, or click the **Copy** button copy the above settings to them.

5. Click the **Apply** button to save and activate the settings.

8.5 Detecting VCA Alarm

Purpose:

The DS-7200/7300/8100/9000 series DVR can receive the VCA alarm sent by analog camera, and the VCA detection must be enabled and configured on the camera settings interface first.

Perform the steps below to set the VCA configuration. The device can provide VCA capability of enabling linkage actions when detecting exceptional event, such as people, vehicles and objects cross a virtual line or intrude a pre-defined region.



- The VCA settings and VCA alarm is supported by 1 analog camera for DS-7200/7300/8100HGHI models and 2 analog camers for DS-7200/7300/8100/9000HQHI models.
- DS-7100-SH does not support VCA.

Steps:

1. Enter VCA Alarm interface of Camera Management and select a camera you want to detect VCA alarm.
Menu> Camera> VCA

The selected camera must support the VCA function.

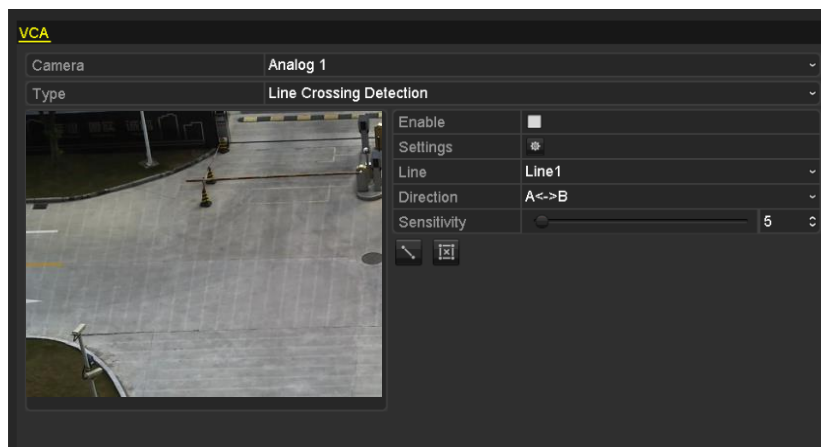

Figure 8. 14 VCA Alarm Setting Interface

2. Select the analog camera to configure the VCA.
3. Select the detection type to **Line Crossing Detection** or **Intrusion Detection**.

Line Crossing Detection: This function can be used for detecting people, vehicles and objects cross a set virtual line. The line crossing direction can be set as bidirectional, from left to right or from right to left. And you can set the duration for the alarm response actions, such as full screen monitoring, audible warning, etc.

Intrusion Detection: This function can be used for detecting whether there are people, vehicles and objects intruding into the pre-defined region longer than the set duration. And you can set the duration for the alarm response actions, such as full screen monitoring, audible warning.
4. Check the **Enable** checkbox to enable the selected VCA detection.
5. Click the  to configure the trigger channel, arming schedule and linkage actions.



Figure 8.15 Set Triggering Channel of VCA Alarm

- 1) Select **Trigger Channel** tab and select one or more channels which will start to record/capture or become full-screen monitoring when a VCA alarm is triggered, and click **Apply** to save the settings.
- 2) Select **Arming Schedule** tab to set the arming schedule of handling actions.

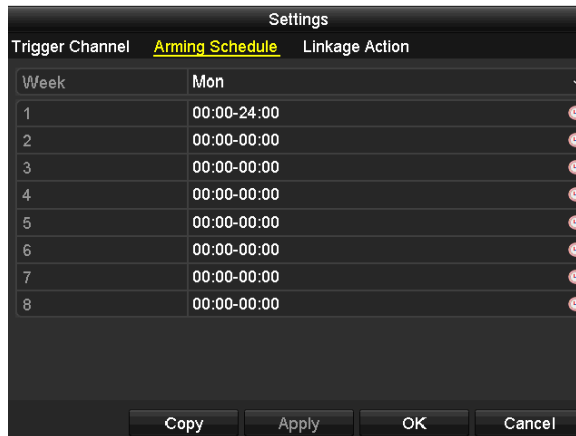

Figure 8.16 Set Arming Schedule of VCA Alarm

Choose one day of a week, and up to 8 time periods can be set within each day. Click **Apply** to save the settings.



Time periods shall not be repeated or overlapped.

Repeat the above steps to set up arming schedule of other days of a week. You can also use **Copy** button to copy an arming schedule to other days.

- 3) Select **Linkage Action** tab to set up alarm response actions of the alarm input (please refer to *Chapter 8.7 Setting Alarm Response Actions*).
 - 4) Click the **OK** button to complete the VCA alarm settings of the channel.
6. Configure the region and other settings for the selected VCA detection.

Task1: Configure the Line Crossing Detection.

- 1) Select the virtual line from the drop-down list. Up to 4 lines are selectable.
- 2) Select the direction to A<->B, A->B or A<-B.

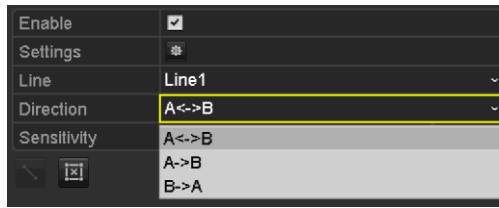



Figure 8.17 Set Direction of Line Crossing Detection

- 3) Set the sensitivity of the line crossing detection to 1-100.
- 4) Click  and set two points in the preview window to draw a virtual line.

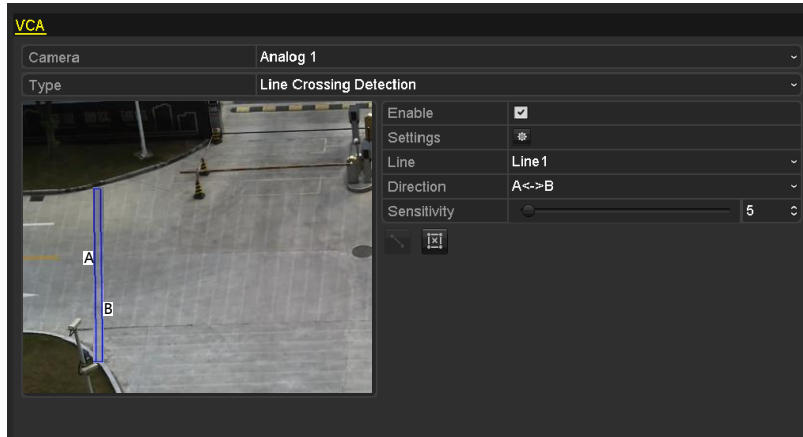



Figure 8.18 Draw Virtual Line in the Image

You can use the  to clear the existing virtual line and re-draw it.

- 5) Click **Apply** to save the settings.

Task2: Configure the Intrusion Detection.

- 1) Select the intrusion region from the drop-down list. Up to 4 regions are selectable.
- 2) Select the sensitivity of the intrusion detection to 1-100.
- 3) Set the percentage to 1-100. Percentage defines the ratio of the region the target object enters that can trigger the alarm. For example, when you set the percentage as 50%, when the target enters half of the region, the alarm will be triggered.

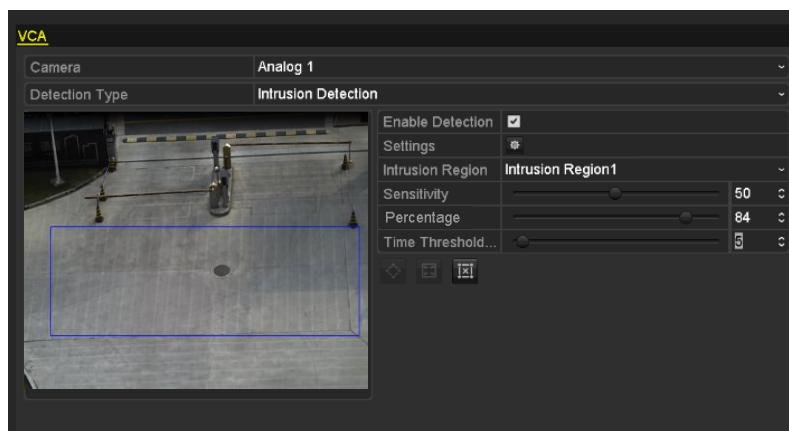





Figure 8.19 Set Intrusion Detection

- 4) Set the time threshold to 0-10 sec. When the duration of the object in the defined detection area is

longer than the set time, the alarm will be triggered.

- 5) Click  and draw a quadrilateral or click  to draw the full screen in the preview window for the selected intrusion region.

You can use the  to clear the existing region and re-draw it.

- 6) Repeat the above steps to set other intrusion regions.
- 7) Click **Apply** to save the settings.

8.6 Setting All-day Video Quality Diagnostics

Purpose:

The device provides two ways to diagnose the video quality: manual and all-day. Perform the following steps to set the threshold of the diagnosing and the linkage actions.

Steps:

1. Enter Video Quality Diagnostics settings interface of Camera Management and select a channel you want to detect video tampering.
Menu> Camera> Video Quality Diagnostics
2. Check the checkbox of Enable Video Quality Diagnostics.
3. Enable and set the threshold of the diagnostic types, there are Blurred Image, Abnormal Brightness, and Color Cast.
Check the corresponding checkbox of the diagnostic type, and adjust the threshold of it by clicking-and-dragging the bar.

The higher the threshold you set, the harder the exception will be detected.

4. Click  to set handling method of video quality diagnostics. Set arming schedule and alarm response actions of the channel.
 - 1) Click **Arming Schedule** tab to set the arming schedule of response action.
 - 2) Choose one day of a week and up to eight time periods can be set within each day.

Time periods shall not be repeated or overlapped.

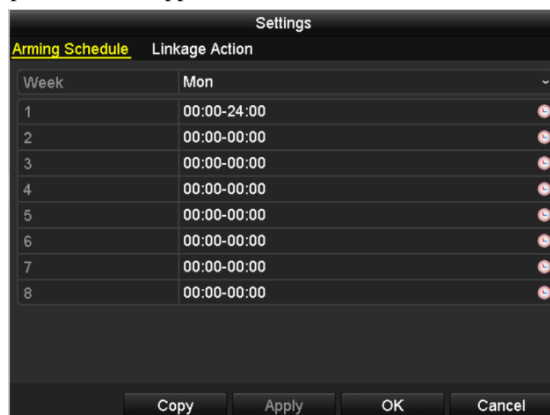

Figure 8. 20 Set Arming Schedule of Video Quality Diagnostics

- 3) Select **Linkage Action** tab to set alarm response actions of video quality diagnostics alarm (please refer to *Chapter 8.8 Setting Alarm Response Actions*).
Repeat the above steps to set arming schedule of other days of a week. You can also use **Copy** button to copy an arming schedule to other days.
- 4) Click the **OK** button to complete the video quality diagnostics settings of the channel.
5. Click the **Apply** button to save and activate settings.
6. (Optional) you can copy the same settings to other cameras by clicking the **Copy** button.

8.7 Handling Exceptions

Purpose:

Exception settings refer to the handling method of various exceptions, e.g.

- **HDD Full:** The HDD is full.
- **HDD Error:** Writing HDD error, unformatted HDD, etc.
- **Network Disconnected:** Disconnected network cable.
- **IP Conflicted:** Duplicated IP address.
- **Illegal Login:** Incorrect user ID or password.
- **Input/Recording Resolution Mismatch:** The input resolution is smaller than the recording resolution.
- **Record Exception:** No space for saving recorded files.

Steps:

1. Enter Exceptions interface and handle various exceptions.

Menu> Configuration> Exceptions



DS-7100HGHI-SH and DS-7200HGHI-SH



Other Models

Figure 8. 21 Exception Settings Interface

2. Check the checkbox of **Enable Event Hint** to display the (Event/Exception icon) when an exceptional event occurs. And click the icon to select the detailed event hint for display.

Click the icon appears in the live view interface, and you can view the detailed information of the exceptional event. Click the button **Set**, and then you can select the detailed event hint for display.



Figure 8. 22 Detailed Event

3. Set the alarm linkage actions. For details, see *Chapter 8.8 Setting Alarm Response Actions*.
4. Click **Apply** to save the settings.

8.8 Setting Alarm Response Actions

Purpose:

Take alarm response actions will be activated when an alarm or exception occurs, including Full Screen Monitoring, Audible Warning (buzzer), Notify Surveillance Center, Send Email and Trigger Alarm Output.

Full Screen Monitoring

When an alarm is triggered, the local monitor (HDMI, VGA or CVBS monitor) display in full screen the video image from the alarming channel configured for full screen monitoring.

If alarms are triggered simultaneously in several channels, their full-screen images will be switched at an interval of 10 seconds (default dwell time). A different dwell time can be set by going to Menu > Configuration > Live View.

Auto-switch will terminate once the alarm stops and you will be taken back to the Live View interface.

Audible Warning

Trigger an audible *beep* when an alarm is detected.

Notify Surveillance Center

Sends an exception or alarm signal to remote alarm host when an event occurs. The alarm host refers to the PC installed with Remote Client.

The alarm signal will be transmitted automatically at detection mode when remote alarm host is configured. Please refer to *Chapter 9.2.6* for details of alarm host configuration.

Send Email

Send an email with alarm information to a user or users when an alarm is detected.

Please refer to *Chapter 9.2.8* for details of Email configuration.

Trigger Alarm Output

Trigger an alarm output when an alarm is triggered.

This function is not supported by DS-7100 and DS-7200HGHI series DVR.

Steps:

1. Enter Alarm Output interface.

Menu> Configuration> Alarm> Alarm Output

Select an alarm output and set alarm name and dwell time. Click  button to set the arming schedule of alarm output.

If “Manually Clear” is selected in the dropdown list of Dwell Time, you can clear it only by going to Menu> Manual> Alarm.

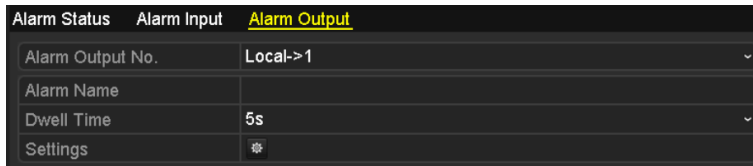

Figure 8. 23 Alarm Output Settings Interface

2. Set up arming schedule of the alarm output.

Choose one day of a week and up to 8 time periods can be set within each day.

Time periods shall not be repeated or overlapped.



Figure 8. 24 Set Arming Schedule of Alarm Output

3. Repeat the above steps to set arming schedule of other days of a week. You can also use Copy button to copy an arming schedule to other days.

Click the **OK** button to complete the arming schedule setting of alarm output.

4. Click the **Apply** button to save the settings.

8.9 Triggering or Clearing Alarm Output Manually



This function is not supported by DS-7100 and DS-7200HGHI series DVR.

Purpose:

Sensor alarm can be triggered or cleared manually. If “Manually Clear” is selected in the dropdown list of dwell time of an alarm output, the alarm can be cleared only by clicking **Clear** button in the following interface.

Steps:

Select the alarm output you want to trigger or clear and make related operations.

Menu> Manual> Alarm

Click **Trigger/Clear** button if you want to trigger or clear an alarm output.

Click **Trigger All** button if you want to trigger all alarm outputs.

Click **Clear All** button if you want to clear all alarm output.

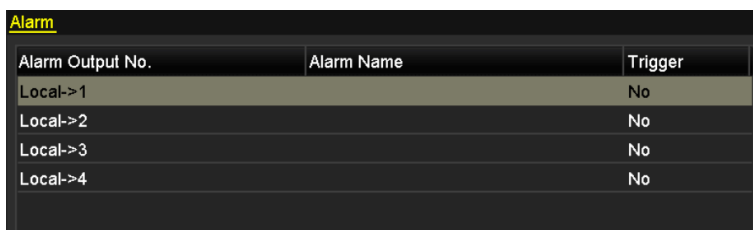

Alarm Output No.	Alarm Name	Trigger
Local->1		No
Local->2		No
Local->3		No
Local->4		No

Figure 8. 25 Clear or Trigger Alarm Output Manually

Chapter 9 Network Settings

9.1 Configuring General Settings

Purpose:

Network settings must be properly configured before you operate DVR over network.

Steps:

1. Enter the Network Settings interface.

Menu > Configuration > Network

Working Mode	Net Fault-tolerance
Select NIC	bond0
NIC Type	10M/100M/1000M Self-adaptive
Enable DHCP	<input type="checkbox"/>
IPv4 Address	172 .6 .21 .159
IPv4 Subnet Mask	255 .255 .255 .0
IPv4 Default Gateway	172 .6 .21 .1
IPv6 Address 1	fec0::a:240:48ff:fe62:dcd/64
IPv6 Address 2	2002:ac06:1578:a:240:48ff:fe62:dcd/64
IPv6 Default Gateway	
MAC Address	00:40:48:62:0d:cd
MTU(Bytes)	1500
Preferred DNS Server	
Alternate DNS Server	
Main NIC	LAN1

DS-8100/9000-SH

NIC Type	10M/100M Self-adaptive
Enable DHCP	<input type="checkbox"/>
IPv4 Address	10 .16 .1 .72
IPv4 Subnet Mask	255 .255 .255 .0
IPv4 Default Gateway	10 .16 .1 .254
IPv6 Address 1	fe80::240:4eff:fe04:acf8/64
IPv6 Address 2	
IPv6 Default Gateway	
MAC Address	00:40:4e:04:ac:f8
MTU(Bytes)	1500
Preferred DNS Server	
Alternate DNS Server	

DS-7100 and DS-7200HGHI

NIC Type	10M/100M/1000M Self-adaptive
Enable DHCP	<input type="checkbox"/>
IPv4 Address	172 .6 .23 .216
IPv4 Subnet Mask	255 .255 .255 .0
IPv4 Default Gateway	172 .6 .23 .1
IPv6 Address 1	fe80::8ee7:48ff:fe24:4214/64
IPv6 Address 2	
IPv6 Default Gateway	
MAC Address	8c:e7:48:24:42:14
MTU(Bytes)	1500
Preferred DNS Server	
Alternate DNS Server	

Other Models

Figure 9. 1 Network Settings Interface



1 self-adaptive 10M/100M network interface for DS-7100, DS-7204/7208HGHI-SH, DS-7200HGHI-E1/E2, DS-7200HGHI-F1/F2 and DS-7204/7208HQHI-E1; 2 self-adaptive 10M/100M/1000M network interfaces for DS-8100HQHI&HGHI-SH and DS-9000HQHI-SH series, with three working modes configurable: multi-address, load balance, network fault tolerance; and 1 self-adaptive 10M/100M/1000M network interface for other models.

2. Select the **General** tab.
3. In the **General Settings** interface, you can configure the following settings: Working mode (applicable for DS-8100/9000 only), NIC Type, IPv4 Address, IPv4 Gateway, MTU and DNS Server.
If the DHCP server is available, you can check the checkbox of **DHCP** to automatically obtain an IP address and other network settings from that server.



The valid value of MTU is from 500 to 1500.

4. After having configured the general settings, click the **Apply** button to save the settings.

Working Mode

There are two 10M/100M/1000M NIC cards provided by the DS-8100HGHI&HQHI-SH series devices, and it allows the device to work in the Multi-address, Load Balance and Net-fault Tolerance modes.

Multi-address Mode: The parameters of the two NIC cards can be configured independently. You can select LAN1 or LAN2 in the NIC type field for parameter settings.

You can select one NIC card as default route. And then the system is connecting with the extranet the data will be forwarded through the default route.

Net-fault Tolerance Mode: The two NIC cards use the same IP address, and you can select the Main NIC to LAN1 or LAN2. By this way, in case of one NIC card failure, the device will automatically enable the other standby NIC card so as to ensure the normal running of the whole system.

Load Balance Mode: By using the same IP address and two NIC cards share the load of the total bandwidth, which enables the system to provide two Gigabit network capacity.

9.2 Configuring Advanced Settings

9.2.1 Configuring Extranet Access

Configuring EZVIZ Cloud P2P

Purpose:

EZVIZ Cloud P2P provides the mobile phone application and as well the service platform page to access and manage your connected DVR, which enables you to get a convenient remote access to the surveillance system.

Steps:

1. Enter the Network Settings interface.
Menu > Configuration > Network
2. Select the **Extranet Access** tab to enter the EZVIZ Cloud P2P Settings interface.
3. The default server address is *dev.ezviz7.com*. If you want to customize the server, you can enable the **Custom** and enter the server address in the text field.
4. Check the **Enable EZVIZ Cloud P2P** checkbox to activate this feature.
5. If required, check the **Enable Stream Encryption** checkbox to encrypt the video stream.
6. Enter the verification code of the device.



The verification code consists of 6 capital letters and is located at the bottom of the DVR. You can also use the scanning tool of your phone to quickly get the code by scanning the QR code below.

Enable EZVIZ Cloud P2P	<input checked="" type="checkbox"/>
Custom	<input type="checkbox"/>
Server Address	dev.ezviz7.com
Enable Stream Encryption	<input type="checkbox"/>
Verification Code	ABCDEF
Status	Offline
Enable DDNS	<input type="checkbox"/>
DDNS Type	HiDDNS
Continent	Custom
Country	
Server Address	www.hik-online.com
Device Domain Name	
User Name	
Password	



Figure 9. 2 EZVIZ Cloud P2P Settings Interface

7. Click the **Apply** button to save and exit the interface.

After configuration, you can access and manage the DVR by your mobile phone on which the EZVIZ Cloud

P2P application is installed or by the EZVIZ website (<http://www.ezviz7.com>).



For more operation instructions, please refer to the help file on the EZVIZ official website (<http://www.ezviz7.com>).

Configuring DDNS

Purpose:

If your DVR is set to use PPPoE as its default network connection, you may set Dynamic DNS (DDNS) to be used for network access.

Prior registration with your ISP is required before configuring the system to use DDNS.

Steps:

1. Enter the Network Settings interface.
Menu > Configuration > Network
2. Select the **DDNS** tab to enter the DDNS Settings interface.

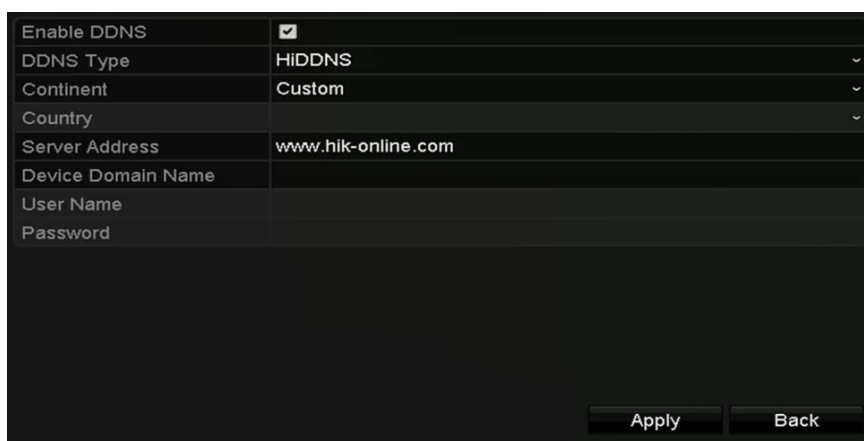

Figure 9.3 DDNS Settings Interface

3. Check the **DDNS** checkbox to enable this feature.
4. Select **DDNS Type**. Five different DDNS types are selectable: IPServer, DynDNS, PeanutHull, NO-IP and HiDDNS.
 - **IPServer:** Enter **Server Address** for IPServer.



Figure 9.4 IPServer Settings Interface

- **DynDNS:**
 - 1) Enter **Server Address** for DynDNS (i.e. members.dyndns.org).

- 2) In the DVR Domain Name text field, enter the domain obtained from the DynDNS website.
- 3) Enter the **User Name** and **Password** registered in the DynDNS website.

Enable DDNS	<input checked="" type="checkbox"/>
DDNS Type	DynDNS
Continent	Custom
Country	
Server Address	members.dyndns.org
Device Domain Name	123.dyndns.com
User Name	test
Password	*****

Figure 9.5 DynDNS Settings Interface

- **PeanutHull:** Enter the **User Name** and **Password** obtained from the PeanutHull website.

Enable DDNS	<input checked="" type="checkbox"/>
DDNS Type	PeanutHull
Continent	Custom
Country	
Server Address	
Device Domain Name	
User Name	123.gicp.net
Password	*****

Figure 9.6 PeanutHull Settings Interface

- **NO-IP:**

Enter the account information in the corresponding fields. Refer to the DynDNS settings.

- 1) Enter **Server Address** for NO-IP.
- 2) In the DVR Domain Name text field, enter the domain obtained from the NO-IP website (www.no-ip.com).
- 3) Enter the **User Name** and **Password** registered in the NO-IP website.

Enable DDNS	<input checked="" type="checkbox"/>
DDNS Type	NO-IP
Continent	Custom
Country	
Server Address	no-ip.org
Device Domain Name	123.no-ip.org
User Name	test
Password	*****

Figure 9.7 NO-IP Settings Interface

- **HiDDNS:**

- 1) Select the continent and country of the server on which the device is registered. You can also select the **Custom** option for customized settings.
- 2) The **Server Address** of the HiDDNS server is set by default: www.hik-online.com. For the **Custom** option, enter the server address on demand.
- 3) Enter the **Device Domain Name**. You can use the alias you registered in the HiDDNS server or define a new device domain name. If a new alias of the device domain name is defined in the DVR, it will replace the old one registered on the server. You can register the alias of the device domain

name in the HiDDNS server first and then enter the alias to the **Device Domain Name** in the DVR; you can also enter the domain name directly on the DVR to create a new one.

Enable DDNS	<input checked="" type="checkbox"/>
DDNS Type	HiDDNS
Continent	Europe
Country	Andorra
Server Address	www.hik-online.com
Device Domain Name	dvr-test
User Name	
Password	

Figure 9. 8 HiDDNS Settings Interface

➤ **Register the device on the HiDDNS server.**

- 1) Go to the HiDDNS website: www.hik-online.com.

Figure 9. 9 Login Interface

- 2) Click **Register** to register an account if you do not have one and use the account to log in.

Figure 9. 10 Register an Account

3) In the Device Management interface, click  to register the device.

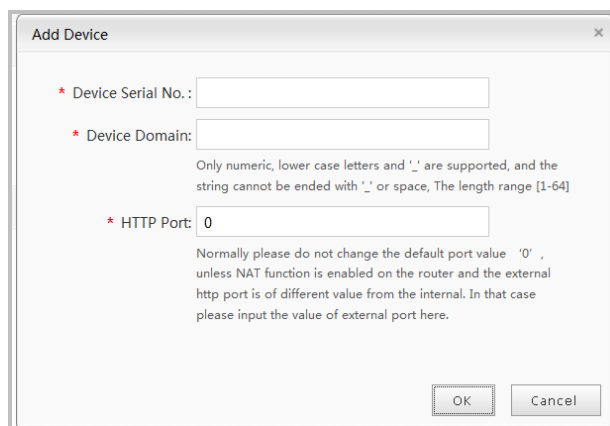

Figure 9. 11 Register the Device

4) Input **Device Serial No.**, **Device Domain (Device Name)** and **HTTP Port**. And click **OK** to add the device.

➤ **Access the Device via Web Browser or Client Software**

After having successfully registered the device on the HiDDNS server, you can access your device via web browser or Client Software with the Device Domain (Device Name).

● **OPTION 1: Access the Device via Web Browser**

Open a web browser, and enter *http://www.hik-online.com/alias* in the address bar. Alias refers to the **Device Domain** on the device or the **Device Name** on the HiDDNS server.

Example: http://www.hik-online.com/nvr



If you mapped the HTTP port on your router and changed it to port No. except 80, you have to enter *http://www.hik-online.com/alias:HTTP port* in the address bar to access the device. You can refer to *Chapter 11.2.8* for the mapped HTTP port No.

● **OPTION 2: Access the devices via iVMS-4200**

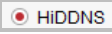
For iVMS-4200, in the Add Device window, select  and then edit the device information.

Nickname: Edit a name for the device as you want.

Server Address: www.hik-online.com

Device Domain Name: It refers to the **Device Domain Name** on the device or the **Device Name** on the HiDDNS server you created.

User Name: Enter the user name of the device.

Password: Enter the password of the device.

Figure 9.12 Access Device via iVMS-4200

5. Click the **Apply** button to save and exit the interface.

9.2.2 Configuring PPPoE Settings

Purpose:

The DVR also allows access by Point-to-Point Protocol over Ethernet (PPPoE).

Steps:

1. Enter the **Network Settings** interface.
Menu > Configuration > Network
2. Select the **PPPoE** tab to enter the PPPoE Settings interface.

Enable PPPOE	<input checked="" type="checkbox"/>
User Name	<input type="text"/>
Password	<input type="text"/>

Figure 9.13 PPPoE Settings Interface

3. Check the **PPPoE** checkbox to enable this feature.
4. Enter **User Name** and **Password** for PPPoE access.

The User Name and Password should be assigned by your ISP.

5. Click the **Apply** button to save the settings.
6. After successful settings, the system asks you to reboot the device to enable the new settings, and the PPPoE dial-up is automatically connected after reboot.
You can go to Menu > Maintenance > System Info > Network interface to view the status of PPPoE connection.

9.2.3 Configuring NTP Server

Purpose:

A Network Time Protocol (NTP) Server can be configured on your DVR to ensure the accuracy of system

date/time.

Steps:

1. Enter the Network Settings interface.
Menu > Configuration > Network
2. Select the **NTP** tab to enter the NTP Settings interface.

Enable NTP	<input checked="" type="checkbox"/>
Interval (min)	60
NTP Server	210.72.145.44
NTP Port	123

Figure 9. 14 NTP Settings Interface

3. Check the **Enable NTP** checkbox to enable this feature.
4. Configure the following NTP settings:
 - **Interval:** Time interval between the two synchronizing actions with NTP server. The unit is minute.
 - **NTP Server:** IP address of NTP server.
 - **NTP Port:** Port of NTP server.
5. Click the **Apply** button to save and exit the interface.



The time synchronization interval can be set from 1 to 10080 minutes, and the default value is 60 minutes. If the DVR is connected to a public network, you should use a NTP server that has a time synchronization function, such as the server at the National Time Center (IP Address: 210.72.145.44). If the DVR is set in a more customized network, NTP software can be used to establish a NTP server used for time synchronization.

9.2.4 Configuring SNMP

Purpose:

You can use SNMP protocol to get device status and parameters related information.

Steps:

1. Enter the Network Settings interface.
Menu > Configuration > Network
2. Select the **SNMP** tab to enter the SNMP Settings interface.

Enable SNMP	<input type="checkbox"/>
SNMP Version	V2
SNMP Port	161
Read Community	public
Write Community	private
Trap Address	
Trap Port	162

Figure 9. 15 SNMP Settings Interface

3. Check the **Enable SNMP** checkbox to enable this feature.
4. Configure the following SNMP settings:
 - **Trap Address:** IP Address of SNMP host.
 - **Trap Port:** Port of SNMP host.



Figure 9. 16 Configure SNMP Settings

5. Click the **Apply** button to save and exit the interface.



Before setting the SNMP, please download the SNMP software and manage to receive the device information via SNMP port. By setting the Trap Address, the DVR is allowed to send the alarm event and exception message to the surveillance center.

9.2.5 Configuring NAT

Purpose:

Universal Plug and Play (UPnP™) can permit the device seamlessly discover the presence of other network devices on the network and establish functional network services for data sharing, communications, etc. You can use the UPnP™ function to enable the fast connection of the device to the WAN via a router without port mapping.

Before you start:

If you want to enable the UPnP™ function of the device, you must enable the UPnP™ function of the router to which your device is connected. When the network working mode of the device is set as multi-address, the Default Route of the device should be in the same network segment as that of the LAN IP address of the router.

Steps:

1. Enter the Network Settings interface.
Menu > Configuration > Network
2. Select the **NAT** tab to enter the UPnP™ settings interface.

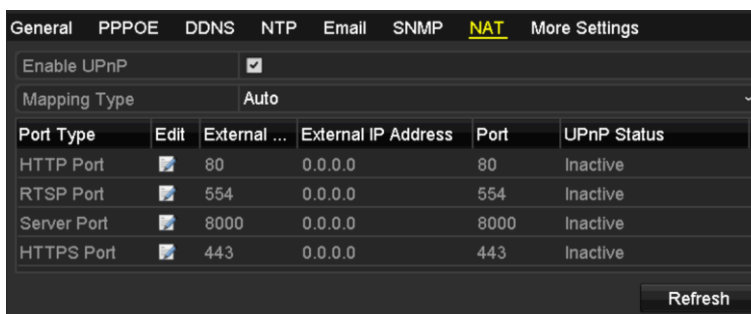

Figure 9. 17 UPnP™ Settings Interface

3. Check checkbox to enable UPnP™.
4. Select the Mapping Type as Manual or Auto in the drop-down list.

OPTION 1: Auto

If you select Auto, the Port Mapping items are read-only, and the external ports are set by the router automatically.

- 1) Click **Apply** button to save the settings.
- 2) You can click **Refresh** button to get the latest status of the port mapping.

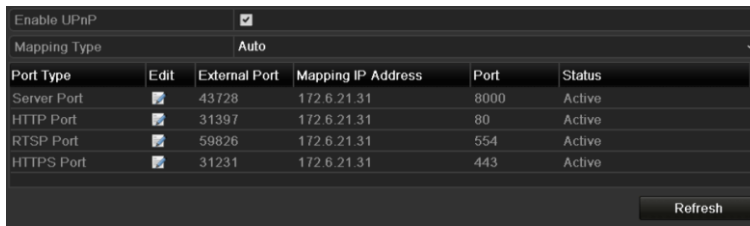

Figure 9. 18 UPnP™ Settings Finished-Auto

OPTION 2: Manual

If you select Manual as the mapping type, you can edit the external port on your demand by clicking to activate the External Port Settings dialog box.

Steps:

- 1) Click to activate the External Port Settings dialog box. Configure the external port No. for server port, http port and RTSP port respectively.



- You can use the default port No., or change it according to actual requirements.
- External Port indicates the port No. for port mapping in the router.
- The value of the RTSP port No. should be 554 or between 1024 and 65535, while the value of the other ports should be between 1 and 65535 and the value must be different from each other. If multiple devices are configured for the UPnP™ settings under the same router, the value of the port No. for each device should be unique.

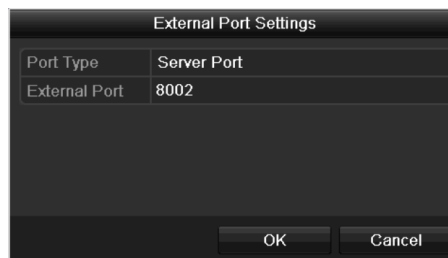

Figure 9. 19 External Port Settings Dialog Box

- 2) Click **Apply** button to save the settings.
- 3) You can click **Refresh** button to get the latest status of the port mapping.

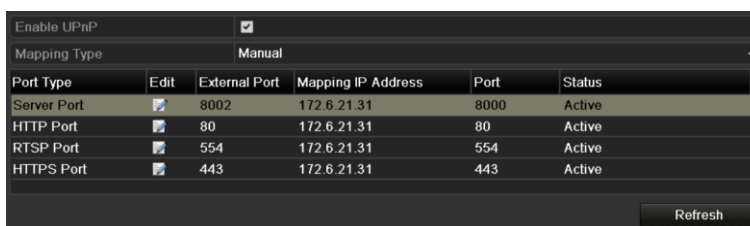

Figure 9. 20 UPnP™ Settings Finished-Manual

9.2.6 Configuring More Settings

Steps:

1. Enter the Network Settings interface.
Menu > Configuration > Network
2. Select the **More Settings** tab to enter the More Settings interface.

Alarm Host IP	
Alarm Host Port	0
Server Port	8000
HTTP Port	80
Multicast IP	
RTSP Port	554

Figure 9.21 More Settings Interface

3. Configure the remote alarm host, server port, HTTP port, multicast, RTSP port.
 - **Alarm Host IP/Port:** With a remote alarm host configured, the device will send the alarm event or exception message to the host when an alarm is triggered. The remote alarm host must have the CMS (Client Management System) software installed.
The **Alarm Host IP** refers to the IP address of the remote PC on which the CMS (Client Management System) software (e.g., iVMS-4200) is installed, and the **Alarm Host Port** must be the same as the alarm monitoring port configured in the software (default port is 7200).
 - **Multicast IP:** The multicast can be configured to realize live view for more than the maximum number of cameras through network. A multicast address spans the Class-D IP range of 224.0.0.0 to 239.255.255.255. It is recommended to use the IP address ranging from 239.252.0.0 to 239.255.255.255.
When adding a device to the CMS (Client Management System) software, the multicast address must be the same as the device's multicast IP.
 - **RTSP Port:** The RTSP (Real Time Streaming Protocol) is a network control protocol designed for use in entertainment and communications systems to control streaming media servers.
Enter the RTSP port in the text field of **RTSP Port**. The default RTSP port is 554, and you can change it according to different requirements.
 - **Server Port and HTTP Port:** Enter the **Server Port** and **HTTP Port** in the text fields. The default Server Port is 8000 and the HTTP Port is 80, and you can change them according to different requirements.



The Server Port should be set to the range of 2000-65535 and it is used for remote client software access. The HTTP port is used for remote IE access.

Alarm Host IP	192.0.0.10
Alarm Host Port	7200
Server Port	8000
HTTP Port	80
Multicast IP	239.252.2.50
RTSP Port	554

Figure 9.22 Configure More Settings

4. Click the **Apply** button to save and exit the interface.

9.2.7 Configuring HTTPS Port

Purpose:

HTTPS provides authentication of the web site and associated web server that one is communicating with, which protects against Man-in-the-middle attacks. Perform the following steps to set the port number of https.

Example:

If you set the port number as 443 and the IP address is 192.0.0.64, you may access the device by inputting `https://192.0.0.64:443` via the web browser.



The HTTPS port can be only configured through the web browser.

Steps:

1. Open web browser, input the IP address of device, and the web server will select the language automatically according to the system language and maximize the web browser.
2. Input the correct user name and password, and click **Login** button to log in the device.
3. Enter the HTTPS settings interface.
Configuration > Remote Configuration > Network Settings > HTTPS
4. Create the self-signed certificate or authorized certificate.

Figure 9.23 HTTPS Settings

OPTION 1: Create the self-signed certificate

- 1) Click the **Create** button to create the following dialog box.

Figure 9.24 Create Self-signed Certificate

- 2) Enter the country, host name/IP, validity and other information.

3) Click **OK** to save the settings.

OPTION 2: Create the authorized certificate

- 1) Click the **Create** button to create the certificate request.
 - 2) Download the certificate request and submit it to the trusted certificate authority for signature.
 - 3) After receiving the signed valid certificate, import the certificate to the device.
5. There will be the certificate information after you successfully create and install the certificate.

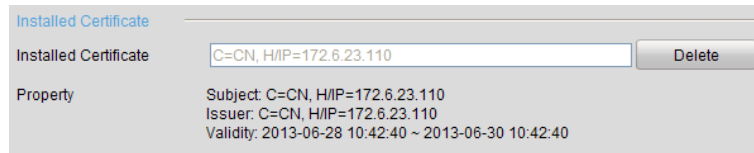

Figure 9. 25 Installed Certificate Property

6. Check the checkbox to enable the HTTPS function.
7. Click the **Save** button to save the settings.

9.2.8 Configuring Email

Purpose:

The system can be configured to send an Email notification to all designated users if an event is detected, e.g. an alarm or motion event is detected, etc.

Before configuring the Email settings, the DVR must be connected to a local area network (LAN) that maintains an SMTP mail server. The network must also be connected to either an intranet or the Internet depending on the location of the e-mail accounts to which you want to send notification. Additionally, the Preferred DNS server must be configured.

Before you start:

Make sure you have configured the IPv4 Address, IPv4 Subnet Mask, IPv4 Gateway and the Preferred DNS Server in the Network Settings menu. Please refer to *Chapter 9.1 Configuring General Settings* for detailed information.

Steps:

1. Enter the Network Settings interface.
Menu > Configuration > Network
2. Select the **Email** tab to enter the Email Settings interface.

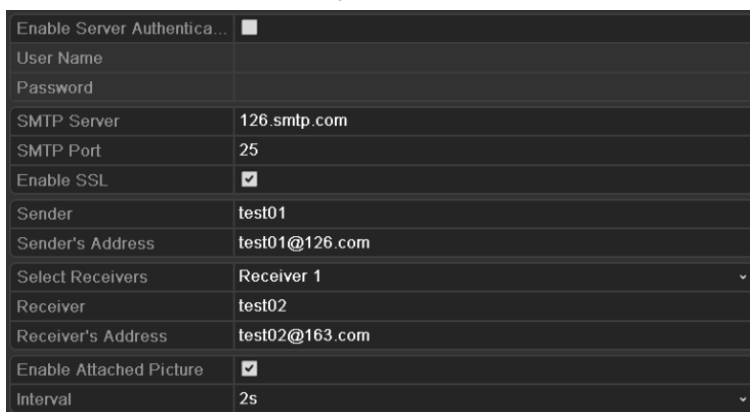

Figure 9. 26 Email Settings Interface

3. Configure the following Email settings:
 - Enable Server Authentication (optional):** Check the checkbox to enable the server authentication feature.
 - User Name:** The user account of sender's Email for SMTP server authentication.
 - Password:** The password of sender's Email for SMTP server authentication.
 - SMTP Server:** The SMTP Server IP address or host name (e.g., smtp.263xmail.com).
 - SMTP Port No.:** The SMTP port. The default TCP/IP port used for SMTP is 25.
 - Enable SSL (optional):** Click the checkbox to enable SSL if required by the SMTP server.
 - Sender:** The name of sender.
 - Sender's Address:** The Email address of sender.
 - Select Receivers:** Select the receiver. Up to 3 receivers can be configured.
 - Receiver:** The name of the receiver of the Email.
 - Receiver's Address:** The Email address of the receiver.
 - Enable Attached Pictures:** Check the checkbox of **Enable Attached Picture** if you want to send email with attached alarm images. The interval is the time between two captures of the alarm images.
 - Interval:** The interval refers to the time between two actions of sending attached pictures.
 - E-mail Test:** Sends a test message to verify that the SMTP server can be reached.
4. Click the **Apply** button to save the Email settings.
5. You can click the **Test** button to test whether your Email settings work. The corresponding Attention message box pops up.

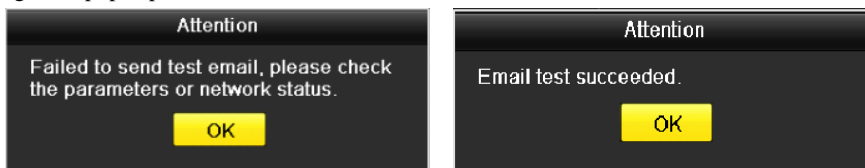

Figure 9. 27 Email Testing Attention

9.3 Checking Network Traffic

Purpose:

You can check the network traffic to obtain real-time information of DVR such as linking status, MTU, sending/receiving rate, etc.

Steps:

1. Enter the Network Traffic interface.
Menu > Maintenance > Net Detect

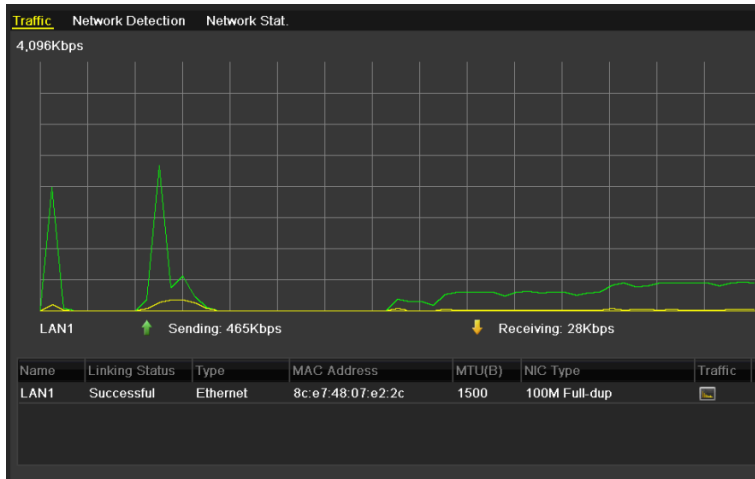

Figure 9. 28 Network Traffic Interface

-
2. You can view the sending rate and receiving rate information on the interface. The traffic data is refreshed every 1 second.

9.4 Configuring Network Detection

Purpose:

You can obtain network connecting status of DVR through the network detection function, including network delay, packet loss, etc.

9.4.1 Testing Network Delay and Packet Loss

Steps:

1. Enter the Network Traffic interface.
Menu > Maintenance > Net Detect
2. Click the **Network Detection** tab to enter the Network Detection menu.

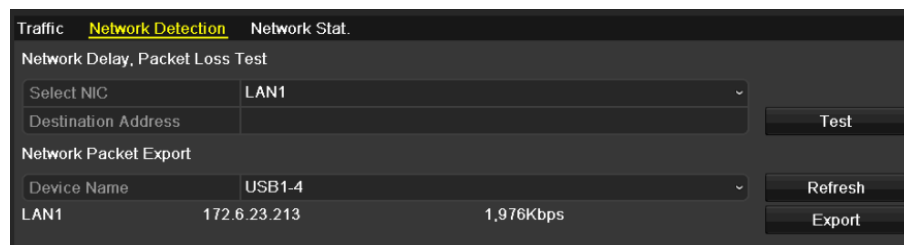

Figure 9. 29 Network Detection Interface

3. Select a NIC to test network delay and packet loss.
4. Enter the destination address in the text field of **Destination Address**.
5. Click the **Test** button to start testing network delay and packet loss.

9.4.2 Exporting Network Packet

Purpose:

By connecting the DVR to network, the captured network data packet can be exported to USB-flash disk, SATA and other local backup devices.

Steps:

1. Enter the Network Traffic interface.
Menu > Maintenance > Net Detect
2. Click the **Network Detection** tab to enter the Network Detection interface.
3. Select the backup device from the dropdown list of Device Name.

Click the **Refresh** button if the connected local backup device cannot be displayed. When it fails to detect the backup device, please check whether it is compatible with the DVR. You can format the backup device if the format is incorrect.

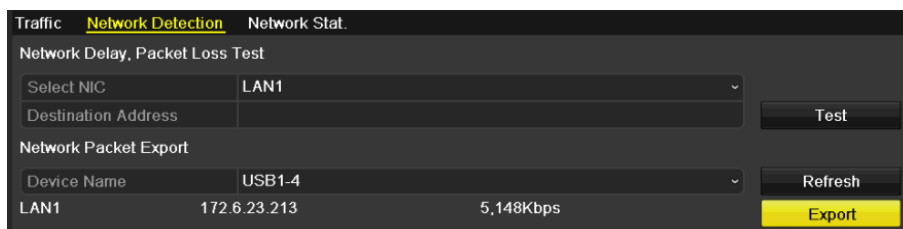

Figure 9.30 Export Network Packet

4. Click the **Export** button to start exporting.
5. After the exporting is complete, click **OK** to finish the packet export.



Up to 1M data can be exported each time.

9.4.3 Checking Network Status

Purpose:

You can also check the network status and quick set the network parameters in this interface.

Steps:

Click Status on the right bottom of the page.

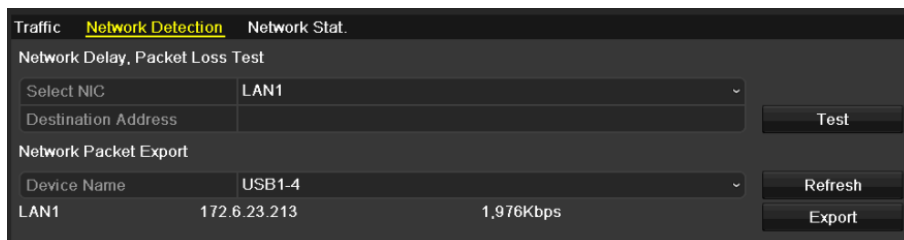

Figure 9.31 Checking Network Status

If the network is normal the following message box pops out.

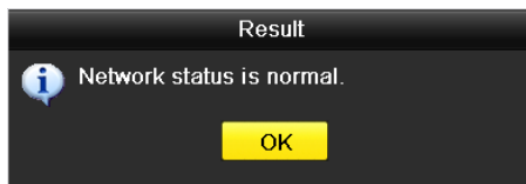

Figure 9.32 Network Status Checking Result

If the message box pops out with other information instead of this one, you can click **Network** button to show the quick setting interface of the network parameters.

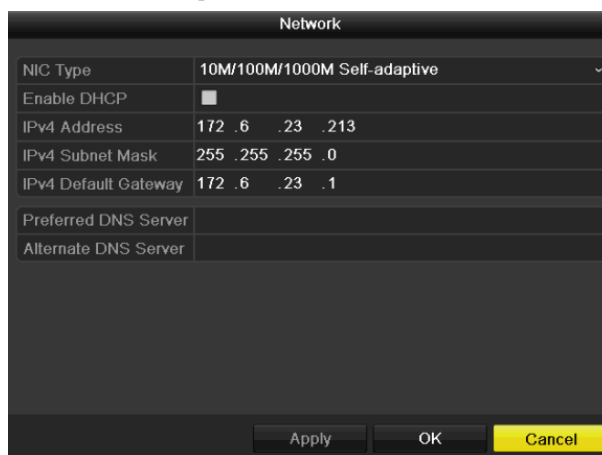

Figure 9.33 Network Parameters Configuration

9.4.4 Checking Network Statistics

Purpose:

You can check the network statistics to obtain the real-time information of the device.

Steps:

1. Enter the Network Statistics interface.
Menu > Maintenance > Net Detect
2. Click the **Network Stat.** tab to enter the Network Statistics menu.

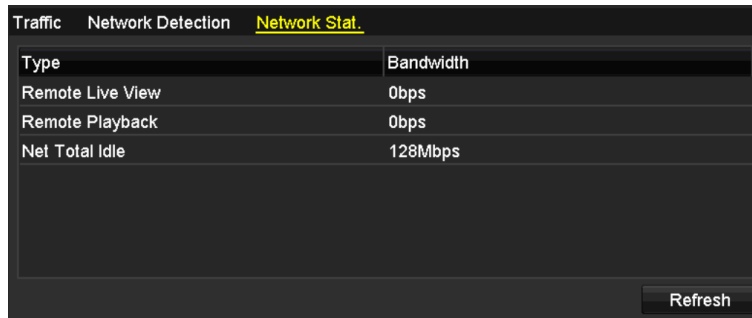

The screenshot shows a web interface with three tabs: 'Traffic', 'Network Detection', and 'Network Stat.'. The 'Network Stat.' tab is selected and highlighted in yellow. Below the tabs is a table with two columns: 'Type' and 'Bandwidth'. The table contains three rows of data. At the bottom right of the interface is a 'Refresh' button.

Type	Bandwidth
Remote Live View	0bps
Remote Playback	0bps
Net Total Idle	128Mbps

Figure 9. 34 Network Stat. Interface

3. View the bandwidth of Remote Live View, bandwidth of Remote Playback, and bandwidth of Net Total Idle.
4. Click **Refresh** button to get the latest bandwidth statistics.

Chapter 10 HDD Management

10.1 Initializing HDDs

Purpose:

A newly installed hard disk drive (HDD) must be initialized before it can be used with your DVR.

Steps:

1. Enter the HDD Information interface.

Menu > HDD>General.

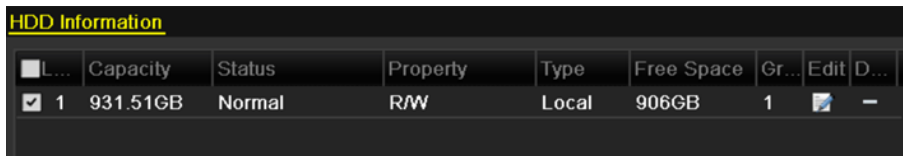

Figure 10. 1 HDD Information Interface

2. Select HDD to be initialized.
3. Click the **Init** button.



Figure 10. 2 Confirm Initialization

4. Select the **OK** button to start initialization.

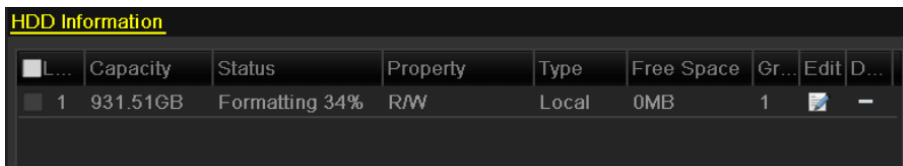

Figure 10. 3 Start Initialization

5. After the HDD has been initialized, the status of the HDD will change from *Uninitialized* to *Normal*.

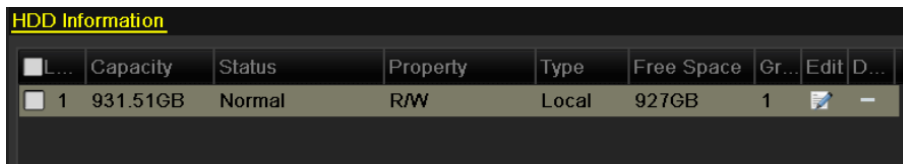

Figure 10. 4 HDD Status Changes to Normal



Initializing the HDD will erase all data on it.

The HDDs which are free of working for a long time can be enabled to sleep, thus to decrease the power

consumption of the device and extend the life of the HDDs.

Click Menu > HDD > Advanced.

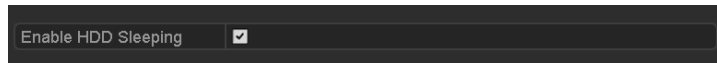

Figure 10.5 Enable HDD Sleeping

Check the checkbox of **Enable HDD Sleeping** (by default), and the HDDs which are free of working for a long time will be set to sleep.

Uncheck the checkbox of **Enable HDD Sleeping**, and the HDDs will be set to work for all time.

10.2 Managing Network HDD

Purpose:

You can add the allocated NAS or disk of IP SAN to DVR, and use it as network HDD.

Steps:

1. Enter the HDD Information interface.

Menu > HDD>General

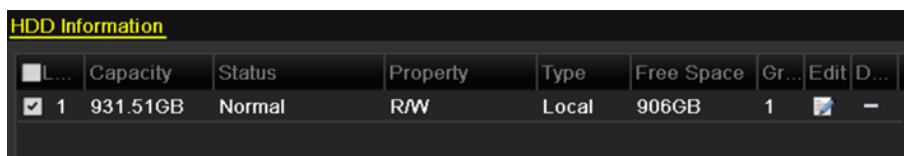

<input type="checkbox"/> L...	Capacity	Status	Property	Type	Free Space	Gr...	Edit	D...
<input checked="" type="checkbox"/> 1	931.51GB	Normal	R/W	Local	906GB	1		-

Figure 10. 6 HDD Information Interface

2. Click the **Add** button to enter the Add NetHDD interface, as shown in Figure 10. 7.

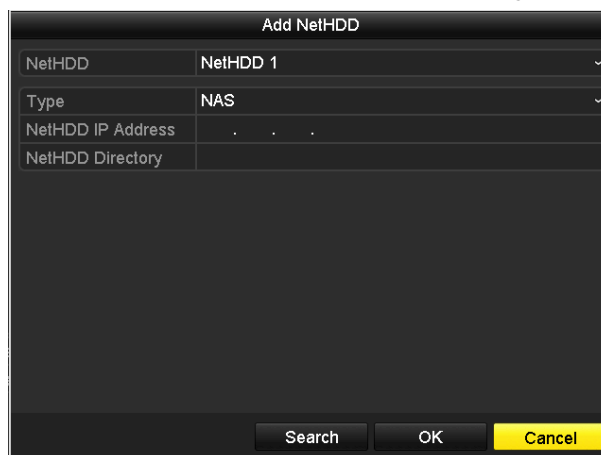

Add NetHDD

NetHDD	NetHDD 1
Type	NAS
NetHDD IP Address	.
NetHDD Directory	

Figure 10. 7 HDD Information Interface

3. Add the allocated NetHDD.
4. Select the type to NAS or IP SAN.
5. Configure the NAS or IP SAN settings.
 - **Add NAS disk:**
 - 1) Enter the NetHDD IP address in the text field.
 - 2) Click **Search** to search the available NAS disks.
 - 3) Select the NAS disk from the list shown below.
Or you can just manually enter the directory in the text field of NetHDD Directory.
 - 4) Click **OK** to add the configured NAS disk.



Up to 8 NAS disks can be added.

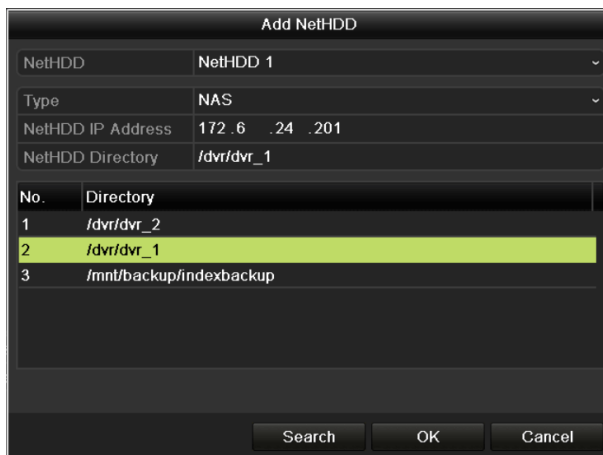

Figure 10. 8 Add NAS Disk

- **Add IP SAN:**
 - 1) Enter the NetHDD IP address in the text field.
 - 2) Click the **Search** button to the available IP SAN disks.
 - 3) Select the IP SAN disk from the list shown below.
 - 4) Click the **OK** button to add the selected IP SAN disk.



Up to 1 IP SAN disk can be added.

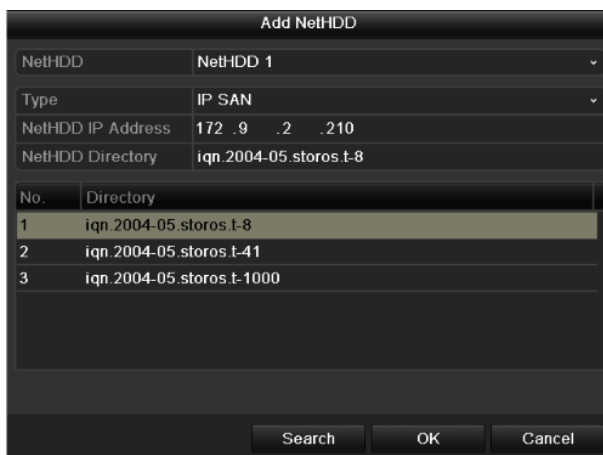

Figure 10. 9 Add IP SAN Disk

- 5) After having successfully added the NAS or IP SAN disk, return to the HDD Information menu. The added NetHDD will be displayed in the list.



If the added NetHDD is uninitialized, please select it and click the **Init** button for initialization.

HDD Information									
<input type="checkbox"/> L...	Capacity	Status	Property	Type	Free Space	Gr...	Edit	D...	
<input checked="" type="checkbox"/> 1	931.51GB	Normal	R/W	Local	906GB	1			
<input checked="" type="checkbox"/> 17	40,000MB	Normal	R/W	IP SAN	22,528MB	1			

Figure 10. 10 Initialize Added NetHDD

10.3 Managing eSATA

Purpose:

When there is an external eSATA device connected to DVR, you can configure eSATA for the use of Record or Export, and you can manage the eSATA in the DVR.

Steps:

1. Enter the Advanced Record Settings interface.
Menu >Record>Advanced
2. Select the eSATA type to Export or Record from the dropdown list of **eSATA**.
Export: use the eSATA for backup. Refer to *Backup using eSATA HDDs* in *Chapter 7.1.1 Backing up by Normal Video Search* for operating instructions.
Record: use the eSATA for record. Refer to the following steps for operating instructions.

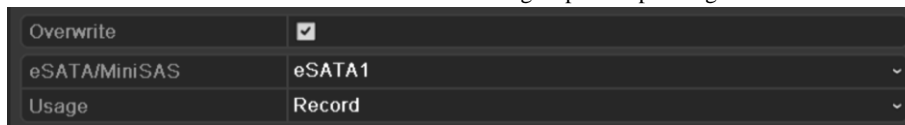

Figure 10. 11 Set eSATA Mode

3. When the eSATA type is selected to Record, enter the HDD Information interface.
Menu > HDD>General
4. Edit the property of the selected eSATA, or initialize it is required.

Two storage modes can be configured for the eSATA when it is used for Record. Please refer to *Chapter 10.4 Managing HDD Group* and *Chapter 10.5 Configuring Quota Mode* for details.

Label	Capacity	Status	Property	Type	Free Space	Gro...	Edit	Del...
4	931.51GB	Normal	R/W	Local	921GB	1		-
18	10,048MB	Uninitialized	R/W	NAS	0MB	1		
25	931.51GB	Normal	R/W	eSATA	894GB	1		

Figure 10. 12 Initialize Added eSATA

10.4 Managing HDD Group

10.4.1 Setting HDD Groups

Purpose:

Multiple HDDs can be managed in groups. Video from specified channels can be recorded onto a particular HDD group through HDD settings.

Steps:

1. Enter the Storage Mode interface.
Menu > HDD > Advanced
2. Set the **Mode** to Group, as shown in Figure 10. 13.

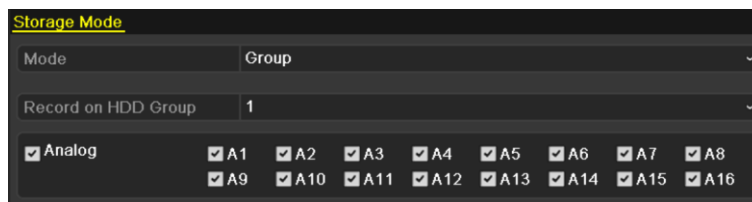

Figure 10. 13 Storage Mode Interface

3. Click the **Apply** button and the following Attention box will pop up.

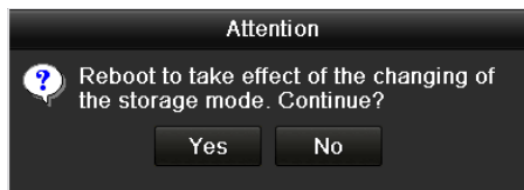



Figure 10. 14 Attention for Reboot

4. Click the **Yes** button to reboot the device to activate the changes.
5. After reboot of device, enter the HDD Information interface.
Menu > HDD > General
6. Select HDD from the list and click the  icon to enter the Local HDD Settings interface, as shown in Figure 10. 15.

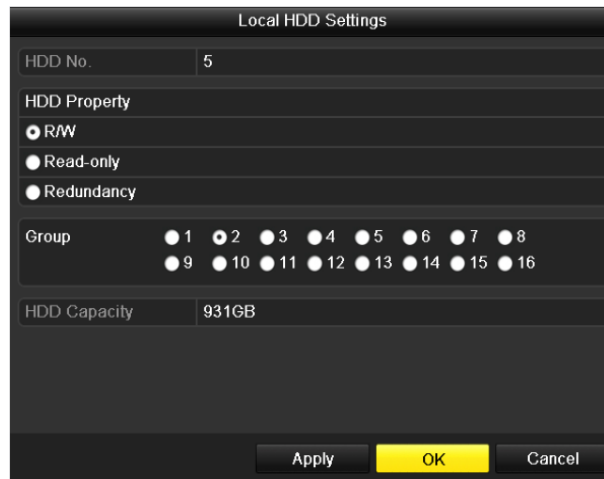

Figure 10.15 Local HDD Settings Interface

7. Select the Group number for the current HDD.

The default group No. for each HDD is 1.

8. Click the **OK** button to confirm the settings.

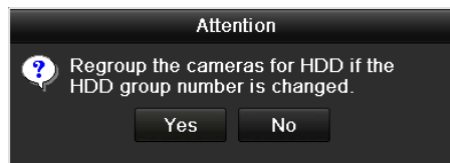

Figure 10.16 Confirm HDD Group Settings

9. In the pop-up Attention box, click the **Yes** button to finish the settings.

10.4.2 Setting HDD Property

Purpose:

The HDD property can be set to redundancy, read-only or read/write (R/W). Before setting the HDD property, please set the storage mode to Group (refer to step1-4 of *Chapter 10.4.1 Setting HDD Groups*).

A HDD can be set to read-only to prevent important recorded files from being overwritten when the HDD becomes full in overwrite recording mode.

When the HDD property is set to redundancy, the video can be recorded both onto the redundancy HDD and the R/W HDD simultaneously so as to ensure high security and reliability of video data.

Steps:

1. Enter the HDD Information interface.
Menu > HDD > General
2. Select HDD from the list and click the  icon to enter the Local HDD Settings interface, as shown in Figure 10.17.



Figure 10.17 Set HDD Property

3. Set the HDD property to R/W, Read-only or Redundancy.
4. Click the **OK** button to save the settings and exit the interface.
5. In the HDD Information menu, the HDD property will be displayed in the list.



At least 2 hard disks must be added on your DVR when you want to set a HDD to Redundancy, and there is one HDD with R/W property.

10.5 Configuring Quota Mode

Purpose

Each camera can be configured with allocated quota for the storage of recorded files.

Steps

1. Enter the Storage Mode interface.
Menu > HDD > Advanced
2. Set the **Mode** to Quota, as shown in Figure 10. 18.



The DVR must be rebooted to enable the changes to take effect.

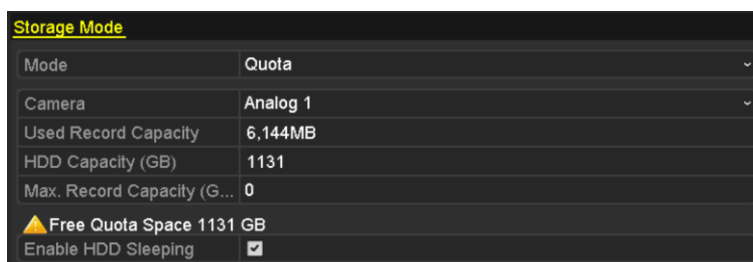

Figure 10. 18 Storage Mode Settings Interface

3. Select a camera for which you want to configure quota.
4. Enter the storage capacity in the text field of **Max. Record Capacity (GB)**.
5. You can copy the quota settings of the current camera to other cameras if required. Click the **Copy** button to enter the Copy Camera interface, as shown in Figure 10. 19.

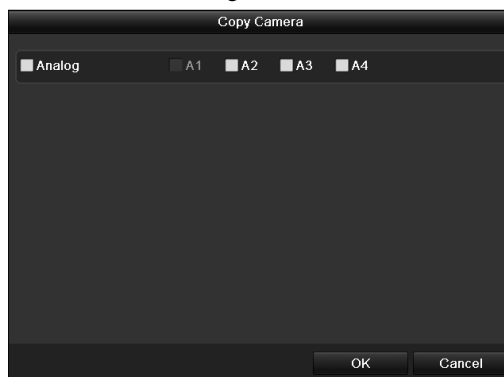

Figure 10. 19 Copy Settings to Other Camera(s)

6. Select the camera (s) to be configured with the same quota settings. You can also click the checkbox of Analog to select all cameras.
7. Click the **OK** button to finish the Copy settings and back to the Storage Mode interface.
8. Click the **Apply** button to apply the settings.



If the quota capacity is set to 0, then all cameras will use the total capacity of HDD for record.

10.6 Checking HDD Status

Purpose:

You may check the status of the installed HDDs on DVR so as to take immediate check and maintenance in case of HDD failure.

Checking HDD Status in HDD Information Interface

Steps:

1. Enter the HDD Information interface.
Menu > HDD>General
2. Check the status of each HDD which is displayed on the list, as shown in Figure 10. 20.



HDD Information							
<input type="checkbox"/> L...	Capacity	Status	Property	Type	Free Space	Gr...	Edit D...
<input type="checkbox"/> 1	931.51GB	Normal	R/W	Local	900GB	1	[-]
<input type="checkbox"/> 17	199.97GB	Normal	Redundancy	NAS	182GB	1	[+]

Figure 10. 20 View HDD Status (1)



If the status of HDD is *Normal* or *Sleeping*, it works normally. If the status is *Uninitialized* or *Abnormal*, please initialize the HDD before use. And if the HDD initialization is failed, please replace it with a new one.

Checking HDD Status in System Information Interface

Steps:

1. Enter the System Information interface.
Menu > Maintenance > System Info
2. Click the **HDD** tab to view the status of each HDD displayed on the list, as shown in Figure 10. 21.

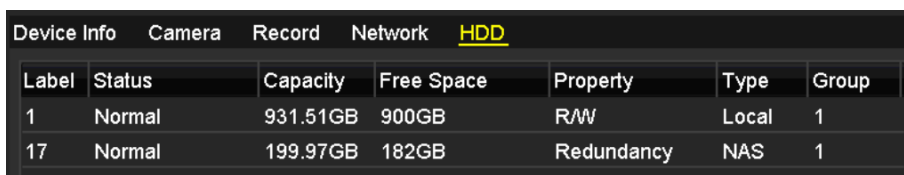

Device Info	Camera	Record	Network	HDD			
Label	Status	Capacity	Free Space	Property	Type	Group	
1	Normal	931.51GB	900GB	R/W	Local	1	
17	Normal	199.97GB	182GB	Redundancy	NAS	1	

Figure 10. 21 View HDD Status (2)

10.7 Checking S.M.A.R.T Information

Purpose:

The S.M.A.R.T. (Self-Monitoring, Analysis and Reporting Technology) is a monitoring system for HDD to detect and report on various indicators of reliability in the hopes of anticipating failures.

Steps:

1. Enter the HDD Detect interface.
Menu > Maintenance > HDD Detect
2. Click the S.M.A.R.T. Settings tab to enter the interface.
3. Select the HDD to view its S.M.A.R.T. information list, as shown in Figure 10. 22.

If you want to use the HDD even when the S.M.A.R.T. checking is failed, you can check the checkbox before the **Continue to use this disk when self-evaluation is failed** item.

The screenshot shows the 'S.M.A.R.T. Settings' window for 'Bad Sector Detection'. At the top, there is a checkbox labeled 'Continue to use this disk when self-evaluation is failed'. Below this, a dropdown menu shows 'HDD 1'. The main area displays several S.M.A.R.T. attributes with their values:

- Self-test Status: Self-test successful
- Self-test Type: Short Test
- S.M.A.R.T.: *
- Temperature (°C): 33
- Power On (days): 185
- Self-evaluation: Pass
- All-evaluation: Functional

Below these settings is a table titled 'S.M.A.R.T. Information' with the following data:

ID	Attribute Name	Status	Flags	Thresh...	Value	Worst	Raw Value
0x1	Raw Read Error Rate	OK	2f	51	200	200	418
0x3	Spin Up Time	OK	27	21	132	107	6366
0x4	Start/Stop Count	OK	32	0	100	100	294
0x5	Reallocated Sector Co...	OK	33	140	200	200	0
0x7	Seek Error Rate	OK	2e	0	200	200	0
0x9	Power-on Hours Count	OK	32	0	94	94	4452
0xa	Spin Up Retry Count	OK	32	0	100	100	0

Figure 10. 22 S.M.A.R.T Settings Interface

10.8 Detecting Bad Sector

Purpose:

You can detect the bad sector of the HDD to check the status of the HDD.

Steps:

1. Enter the HDD Detect interface.

Menu>HDD>HDD Detect

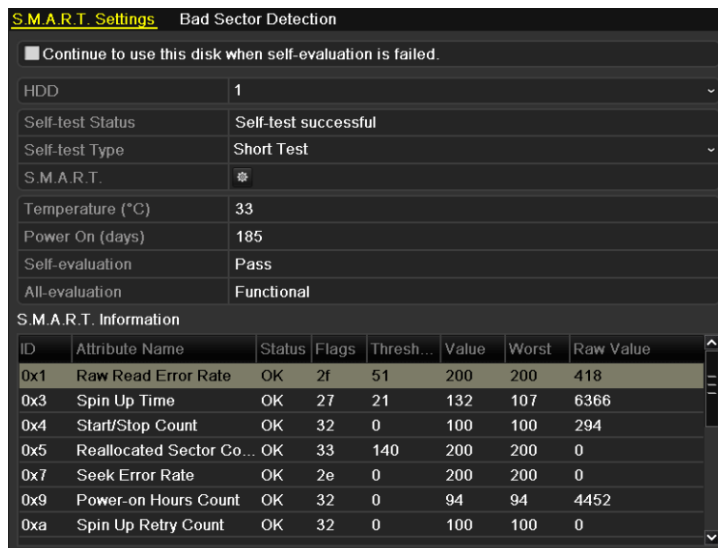

Figure 10. 23 Bad Sector Detection

2. Click the Bad Sector Detection tab to enter the interface.
3. Select a HDD and click the **Detect** button to start detecting.

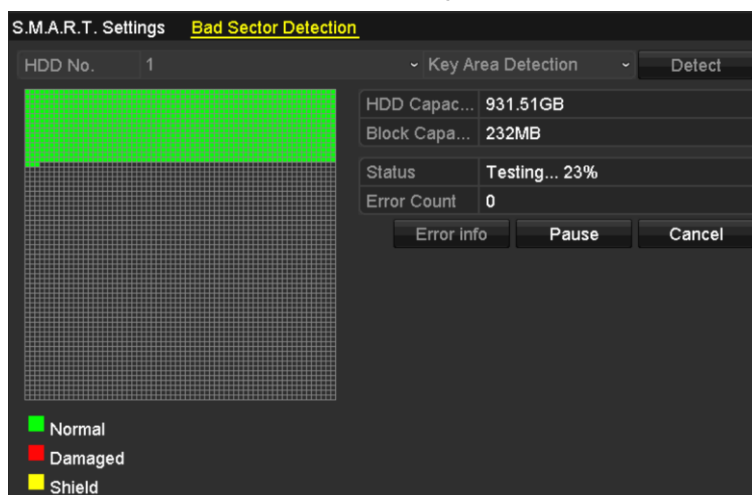

Figure 10. 24 Bad Sector Detecting

4. You can click the **Pause** button to pause the detection and click the **Resume** button to resume the detection.
5. If there is error information about the HDD, you can click the **Error Info** button to view the information.

10.9 Configuring HDD Error Alarms

Purpose:

You can configure the HDD error alarms when the HDD status is *Uninitialized* or *Abnormal*.

Steps:

1. Enter the Exception interface.
Menu > Configuration > Exceptions
2. Select the Exception Type to **HDD Error** from the dropdown list.
3. Check the checkbox(s) below to select the linkage action(s) for HDD error, as shown in Figure 10. 25.
The linkage actions can be selected to: Audible Warning, Notify Surveillance Center, Send Email and Trigger Alarm Output.

Trigger alarm output is applicable to the DS-7300/8100/9000 series DVR.

Please refer to *Chapter 8.8 Setting Alarm Response Actions*.

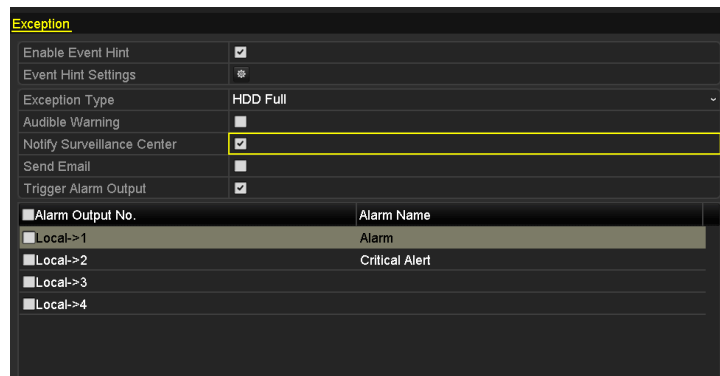

Figure 10. 25 Configure HDD Error Alarm

4. When the Trigger Alarm Output is selected, you can also select the alarm output to be triggered from the list below.
5. Click the **Apply** button to save the settings.

Chapter 11 Camera Settings

11.1 Configuring OSD Settings

Purpose:

You can configure the OSD (On-screen Display) settings for the camera, including date /time, camera name, etc.

Steps:

1. Enter the OSD Configuration interface.
Menu > Camera > OSD
2. Select the camera to configure OSD settings.
3. Edit the Camera Name in the text field.
4. Configure the Display Name, Display Date and Display Week by checking the checkbox.
5. Select the Date Format, Time Format, Display Mode and the OSD font.

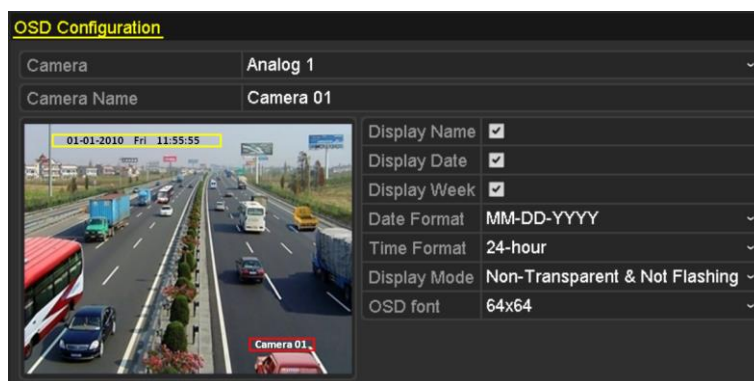

Figure 11. 1 OSD Configuration Interface

6. You can use the mouse to click and drag the text frame on the preview window to adjust the OSD position.
7. Copy Camera Settings
 - 1) If you want to copy the OSD settings of the current camera to other cameras, click the **Copy** button to enter the Copy Camera interface, as shown in Figure 11. 2.

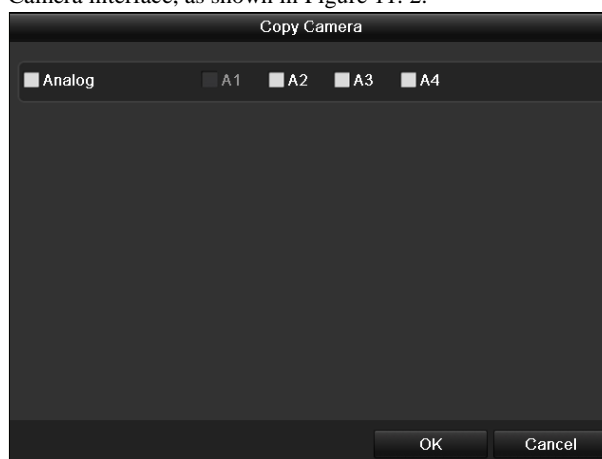

Figure 11. 2 Copy Settings to Other Cameras

- 2) Select the camera (s) to be configured with the same OSD settings. You can also check the checkbox of Analog to select all cameras.
- 3) Click the **OK** button to finish the Copy settings and back to the OSD Configuration interface.
8. Click the **Apply** button to apply the settings.

11.2 Configuring Privacy Mask

Purpose:

You are allowed to configure the four-sided privacy mask zones that cannot be viewed or recorded by the operator.

Steps:

1. Enter the Privacy Mask Settings interface.
Menu > Camera > Privacy Mask
2. Select the camera to set privacy mask.
3. Check the checkbox of **Enable Privacy Mask** to enable this feature.



Figure 11.3 Privacy Mask Settings Interface

4. Use the mouse to draw a zone on the window. The zones will be marked with different frame colors.

Up to 4 privacy mask zones can be configured, and the size of each area can be adjusted.

5. The configured privacy mask zones on the window can be cleared by clicking the corresponding Clear Zone1-4 icons on the right side of the window, or click **Clear All** to clear all zones.



Figure 11.4 Set Privacy Mask Area

6. You can click the **Copy** button to copy the privacy mask settings of the current camera to other cameras.
Please refer to step 7 of *Chapter 11.1 Configuring OSD Settings*.
7. Click the **Apply** button to save the settings.

11.3 Configuring Video Parameters

Steps:

1. Enter the Image Settings interface.

Menu > Camera > Image

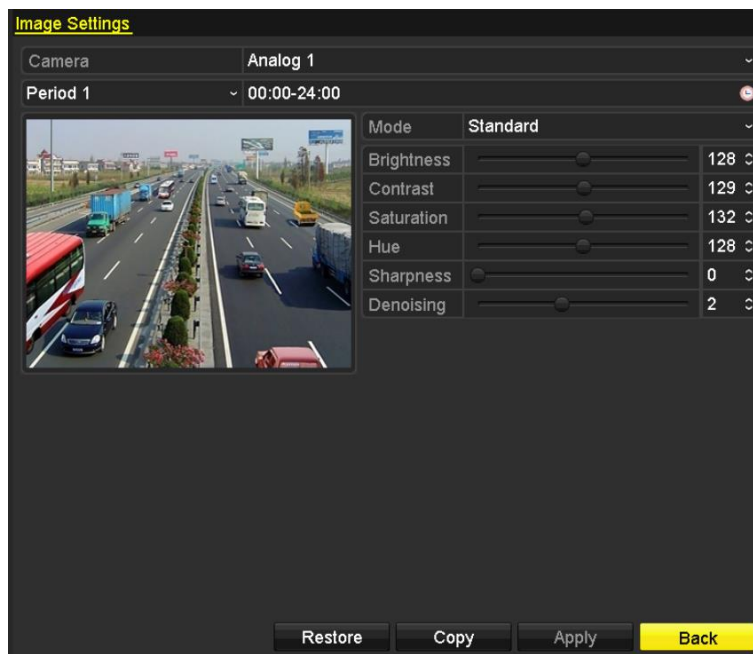

Figure 11. 5 Image Settings Interface

2. Select the camera to set image parameters.
3. Two periods for different image settings are provided, select the period name in the dropdown list.

The time periods cannot be overlapped with each other.

4. Select the mode from the drop-down list of **Mode**, there are four modes selectable: Standard, Indoor, Dim Light and Outdoor.
5. Adjust the image parameters according to actual needs. The parameters include Brightness, Contrast, Saturation, Hue, Sharpness and Denoising. You can also click **Restore** to set the parameters to the default settings.
6. You can click **Copy** to copy the image settings of the current camera to other analog cameras.
7. Click **Apply** to save the settings.

Chapter 12 DVR Management and Maintenance

12.1 Viewing System Information

Steps:

1. Enter the System Information interface.
Menu > Maintenance > System Info
2. You can click the **Device Info**, **Camera**, **Record**, **Alarm**, **Network** and **HDD** tabs to view the system information of the device.



Figure 12. 1 System Information Interface

This alarm information is not available for the DS-7100 and DS-7200HGHI series.

12.2 Searching and Exporting Log Files

Purpose:

The operation, alarm, exception and information of the DVR can be stored in log files, which can be viewed and exported at any time.

Steps:

1. Enter the Log Search interface.
Menu > Maintenance > Log Search

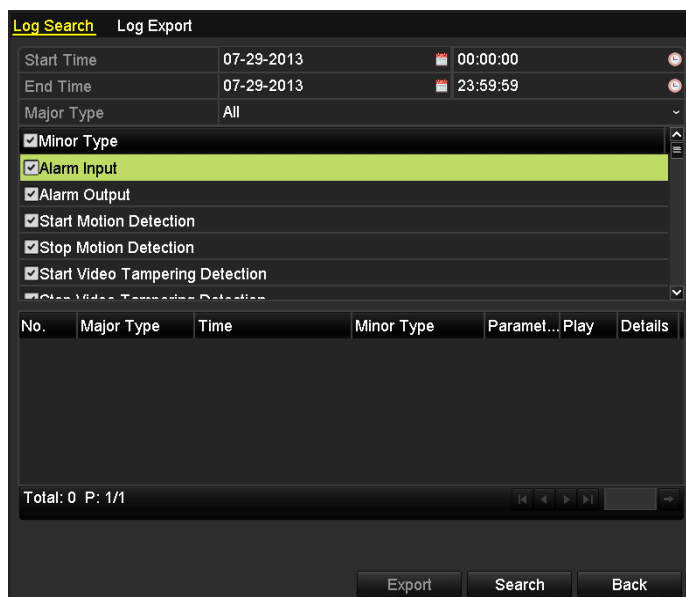

Figure 12. 2 Log Search Interface

2. Set the log search conditions to refine your search, including the Start Time, End Time, Major Type and Minor Type.
3. Click the **Search** button to start search log files.
4. The matched log files will be displayed on the list shown below.



Up to 2000 log files can be displayed each time.

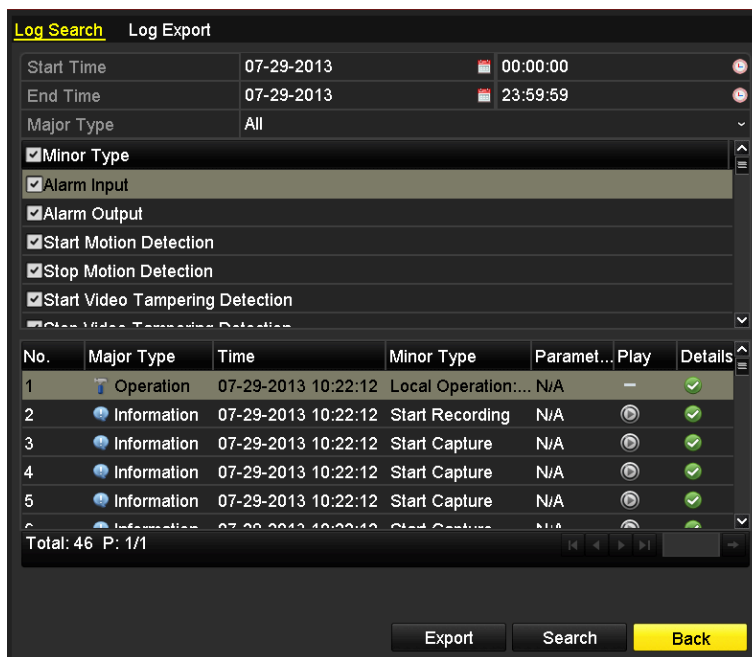

Figure 12. 3 Log Search Results

5. You can click the button of each log or double-click it to view its detailed information, as shown in Figure 12. 4. And you can also click the button to view the related video files if available.



Figure 12. 4 Log Details

6. If you want to export the log files, click the **Export** button to enter the Export menu, as shown in Figure 12. 5.



Figure 12. 5 Export Log Files

7. Select the backup device from the dropdown list of **Device Name**.
8. Click the **Export** to export the log files to the selected backup device.
 You can click the **New Folder** button to create new folder in the backup device, or click the **Format** button to format the backup device before log export.

- Please connect the backup device to DVR before operating log export.
- The log files exported to the backup device are named by exporting time, e.g., *20110514124841logBack.txt*.

12.3 Importing/Exporting IP Camera Info

The network camera connection is not supported by DS-7100 series.

Purpose:

The information of added IP camera can be generated into an excel file and exported to the local device for backup, including the IP address, manage port, password of admin, etc. And the exported file can be edited on your PC, like adding or deleting the content, and copy the setting to other devices by importing the excel file to it.

Steps:

1. Enter the camera management interface.
Menu > Camera > IP Camera Import/Export
2. Click the IP Camera Import/Export tab, the content of detected plugged external device appears.
3. Click the **Export** button to export configuration files to the selected local backup device.
4. To import a configuration file, select the file from the selected backup device and click the **Import** button.
After the importing process is completed, you must reboot the DVR.

12.4 Importing/Exporting Configuration Files

Purpose:

The configuration files of the DVR can be exported to local device for backup; and the configuration files of one DVR can be imported to multiple DVR devices if they are to be configured with the same parameters.

Steps:

1. Enter the Import/Export Configuration File interface.

Menu > Maintenance > Import/Export



Figure 12. 6 Import/Export Config File

2. Click the **Export** button to export configuration files to the selected local backup device.
3. To import a configuration file, select the file from the selected backup device and click the **Import** button. After the import process is completed, you must reboot the DVR.

After having finished the import of configuration files, the device will reboot automatically.

12.5 Upgrading System

Purpose:

The firmware on your DVR can be upgraded by local backup device or remote FTP server.

12.5.1 Upgrading by Local Backup Device

Steps:

1. Connect your DVR with a local backup device where the update firmware file is located.
2. Enter the Upgrade interface.
Menu > Maintenance > Upgrade
3. Click the **Local Upgrade** tab to enter the local upgrade menu, as shown in Figure 12. 7.

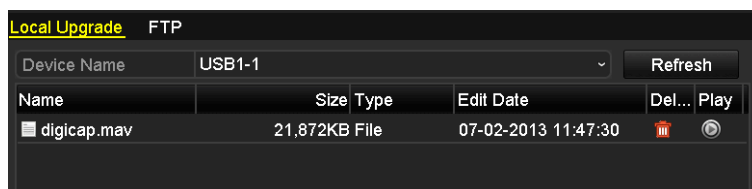

Figure 12. 7 Local Upgrade Interface

4. Select the update file from the backup device.
5. Click the **Upgrade** button to start upgrading.
6. After the upgrading is complete, reboot the DVR to activate the new firmware.

12.5.2 Upgrading by FTP

Before you start:

Configure PC (running FTP server) and DVR to the same Local Area Network. Run the 3rd-party TFTP software on the PC and copy the firmware into the root directory of TFTP.

Steps:

1. Enter the Upgrade interface.
Menu > Maintenance > Upgrade
2. Click the **FTP** tab to enter the local upgrade interface, as shown in Figure 12. 8.

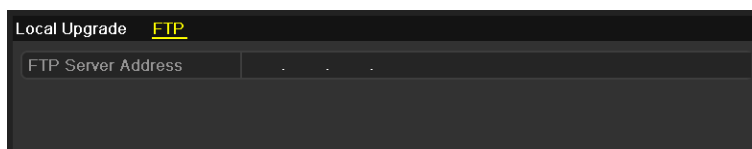

Figure 12. 8 FTP Upgrade Interface

3. Enter the FTP Server Address in the text field.
4. Click the **Upgrade** button to start upgrading.
5. After the upgrading is complete, reboot the DVR to activate the new firmware.

12.6 Restoring Default Settings

Steps:

1. Enter the Default interface.

Menu > Maintenance > Default

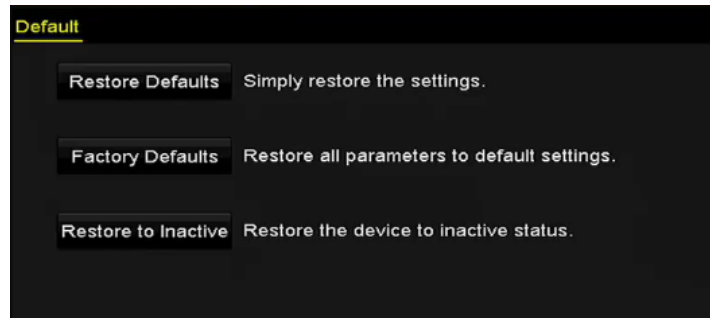

Figure 12. 9 Restore Defaults

2. Select the restoring type from the following three options.

Restore Defaults: Restore all parameters, except the network (including IP address, subnet mask, gateway, MTU, NIC working mode, default route, server port, etc.) and user account parameters, to the factory default settings.

Factory Defaults: Restore all parameters to the factory default settings.

Restore to Inactive: Restore the device to the inactive status.

3. Click the **OK** button to restore the default settings.



The device will reboot automatically after restoring to the default settings.

Chapter 13 Others

13.1 Configuring RS-232 Serial Port

Purpose:

The RS-232 port can be used in two ways:

Parameters Configuration: Connect a PC to the device through the PC serial port. Device parameters can be configured by using software such as HyperTerminal. The serial port parameters must be the same as the device's when connecting with the PC serial port.

Transparent Channel: Connect a serial device directly to the device. The serial device will be controlled remotely by the PC through the network.



RS-232 serial port is not available for DS-7100 and DS-7200 series.

Steps:

1. Enter the RS-232 Settings interface.

Menu > Configuration > RS-232

RS-232 Settings	
Baud Rate	115200
Data Bit	8
Stop Bit	1
Parity	None
Flow Ctrl	None
Usage	Console

Figure 13.1 RS-232 Settings Interface

2. Configure RS-232 parameters, including baud rate, data bit, stop bit, parity, flow control and usage.
3. Click **Apply** to save the settings.

13.2 Configuring General Settings

Purpose:

You can configure the output resolution, system time, mouse pointer speed, etc.

Steps:

1. Enter the General Settings interface.
Menu > Configuration > General
2. Select the **General** tab.



Figure 13. 2 General Settings Interface

DS-8124/8132HGHI-SH provides HDMI1, HDMI2 and VGA outputs.

3. Configure the following settings:
 - **Language:** The default language used is *English*.
 - **CVBS Output Standard:** Select the CVBS output standard to NTSC or PAL, which must be the same with the video input standard.

DS-7100, DS-7200, DS-7324/7332HGHI and DS-8124/8132HGHI provide no CVBS output.

- **Resolution:** Select the output resolution, which must be the same with the resolution of the VGA/HDMI display.
 - **Time Zone:** Select the time zone.
 - **Date Format:** Select the date format.
 - **System Date:** Select the system date.
 - **System Time:** Select the system time.
 - **Mouse Pointer Speed:** Set the speed of mouse pointer; 4 levels are configurable.
 - **Enable Wizard:** Enable/disable the Wizard when the device starts up.
 - **Enable ID Authentication:** Enable/disable the use of the login password.
4. Click the **Apply** button to save the settings.

13.3 Configuring DST Settings

Steps:

1. Enter the General Settings interface.
Menu >Configuration>General
2. Choose **DST Settings** tab.

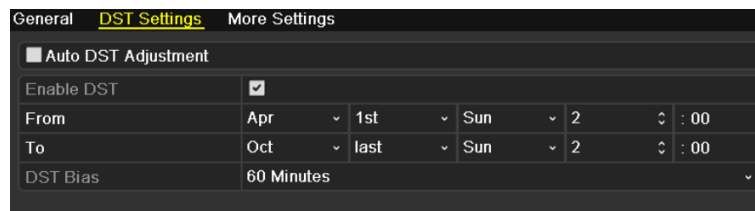

The screenshot shows the 'DST Settings' tab in a configuration interface. It includes the following elements:

- Navigation tabs: General, **DST Settings**, More Settings
- Section header: Auto DST Adjustment
- Enable DST:
- From: Apr 1st Sun 2 :00
- To: Oct last Sun 2 :00
- DST Bias: 60 Minutes

Figure 13. 3 DST Settings Interface

You can check the checkbox before the **Auto DST Adjustment** item.

Or you can manually check the **Enable DST** checkbox, and then you choose the date of the DST period.

13.4 Configuring More Settings

Steps:

1. Enter the General Settings interface.
Menu > Configuration > General
2. Click the **More Settings** tab to enter the More Settings interface, as shown in Figure 13.3.

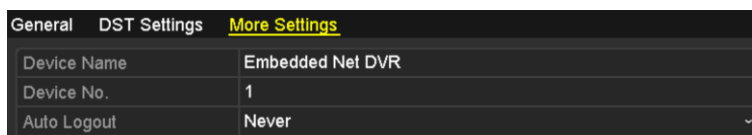

DS-7100-SH, DS-7200-SH, DS-7324/7332HGHI and DS-8124/8132HGHI

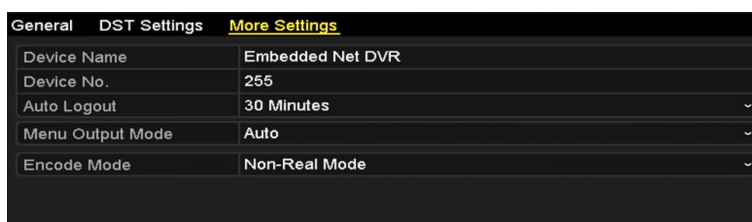

DS-7100/7200-E1(E2)

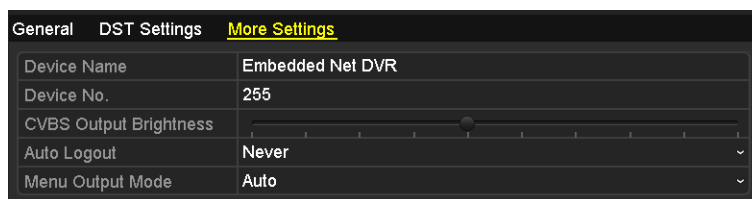

Other Models

Figure 13. 4 More Settings Interface

3. Configure the following settings:
 - **Device Name:** Edit the name of DVR.
 - **Device No.:** Edit the serial number of DVR. The Device No. can be set in the range of 1~255, and the default No. is 255.
 - **CVBS Output Brightness:** Adjust the video output brightness via the CVBS interface.

DS-7100, DS-7200, DS-7324/7332HGHI and DS-8124/8132HGHI provide no CVBS output.

- **Auto Logout:** Set timeout time for menu inactivity. E.g., when the timeout time is set to *5 Minutes*, then the system will exit from the current operation menu to live view screen after 5 minutes of menu inactivity.
- **Menu Output Mode:** You can choose the menu display on different video output.
- **Encode Mode:** For the DS-7100HGHI-E1, DS-7200HGHI-E1 and DS-7200HGHI-E2 models, you can select the encode mode or non-real mode. When the non-real mode is selected, the max. frame rate (menu>record>parameters) can be set to 15fps only.
- Click the **Apply** button to save the settings.

13.5 Managing User Accounts

Purpose:

There is a default account in the NVR: *Administrator*. The *Administrator* user name is *admin* and the password is set when you start the device for the first time. The *Administrator* has the permission to add and delete user and configure user parameters.

13.5.1 Adding a User

Steps:

1. Enter the User Management interface.

Menu >Configuration>User

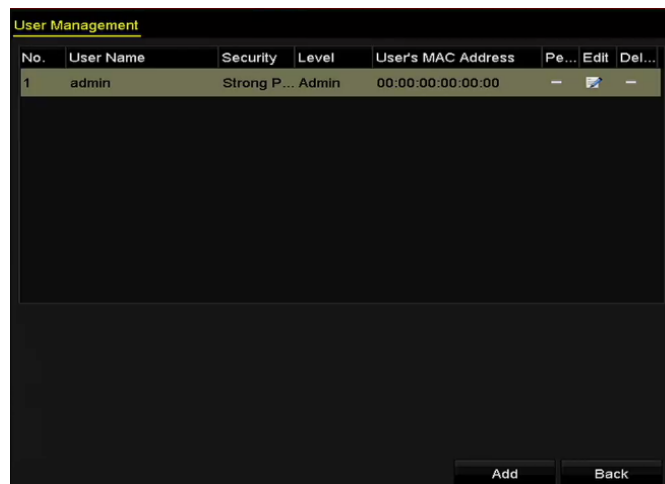
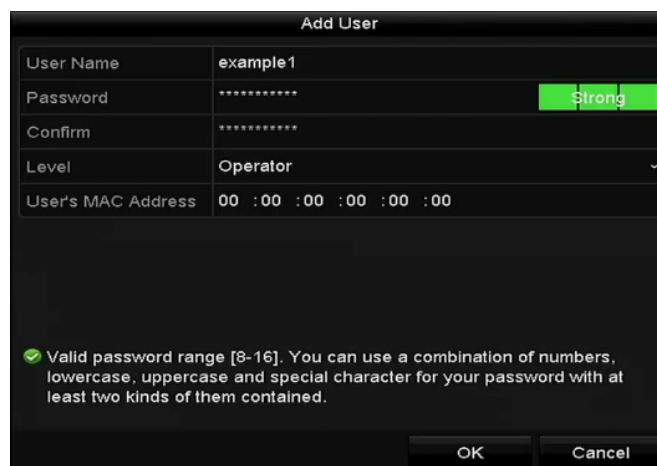

Figure 13. 5 User Management Interface

2. Click the **Add** button to enter the Add User interface.



User Name	example1
Password	***** Strong
Confirm	*****
Level	Operator
User's MAC Address	00 : 00 : 00 : 00 : 00 : 00

Valid password range [8-16]. You can use a combination of numbers, lowercase, uppercase and special character for your password with at least two kinds of them contained.

Figure 13. 6 Add User Menu

3. Enter the information for new user, including **User Name**, **Password**, **Confirm**, **Level** and **User's MAC**

Address.

Password: Set the password for the user account.

 **STRONG PASSWORD RECOMMENDED**– We highly recommend you create a strong password of your own choosing (using a minimum of 8 characters, including upper case letters, lower case letters, numbers, and special characters) in order to increase the security of your product. And we recommend you reset your password regularly, especially in the high security system, resetting the password monthly or weekly can better protect your product.

Level: Set the user level to Operator or Guest. Different user levels have different operating permission.

- **Operator:** The *Operator* user level has permission of Two-way Audio in Remote Configuration and all operating permission in Camera Configuration by default.
- **Guest:** The Guest user has no permission of Two-way Audio in Remote Configuration and only has the local/remote playback in the Camera Configuration by default.

User's MAC Address: The MAC address of the remote PC which logs onto the NVR. If it is configured and enabled, it only allows the remote user with this MAC address to access the NVR.

4. Click the **OK** button to save the settings and go back to the User Management interface. The added new user will be displayed on the list, as shown in Figure 13. 7.

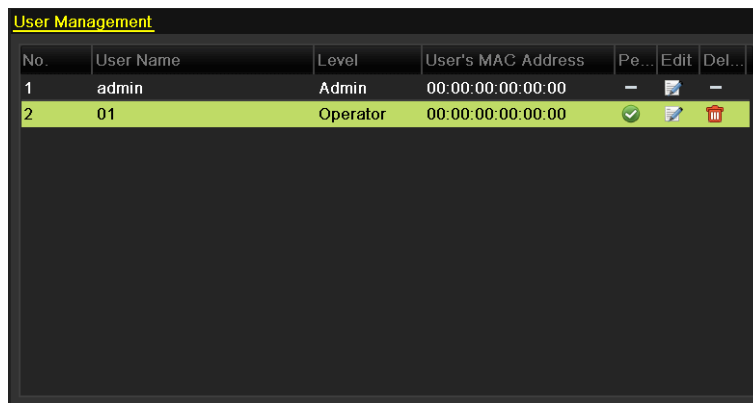

Figure 13. 7 Added User Listed in User Management Interface

5. You can assign permissions for the added user.
 - (1) Select the user from the list and then click the  button to enter the Permission settings interface, as shown in Figure 13. 8.



Figure 13. 8 User Permission Settings Interface

- (2) Set the operating permission of Local Configuration, Remote Configuration and Camera Configuration for the user.

Local Configuration

- Local Log Search: Searching and viewing logs and system information of device.
- Local Parameters Settings: Configuring parameters, restoring factory default parameters and importing/exporting configuration files.
- Local Camera Management: Enabling and disabling analog camera (s). Adding, deleting and editing of network camera (s). This function is supported by HDVR series.
- Local Advanced Operation: Operating HDD management (initializing HDD, setting HDD property), upgrading system firmware, clearing I/O alarm output.
- Local Shutdown /Reboot: Shutting down or rebooting the device.

Remote Configuration

- Remote Log Search: Remotely viewing logs that are saved on the device.
- Remote Parameters Settings: Remotely configuring parameters, restoring factory default parameters and importing/exporting configuration files.
- Remote Camera Management: Remotely enabling and disabling analog camera (s), and adding, deleting and editing of network camera (s). This function is supported by HDVR series.
- Remote Serial Port Control: Configuring settings for RS-232 and RS-485 ports.
- Remote Video Output Control: Sending remote control panel signal.
- Two-way Audio: Realizing two-way radio between the remote client and the device.
- Remote Alarm Control: Remotely arming (notify alarm and exception message to the remote client) and controlling the alarm output.
- Remote Advanced Operation: Remotely operating HDD management (initializing HDD, setting HDD property), upgrading system firmware, clearing I/O alarm output.
- Remote Shutdown/Reboot: Remotely shutting down or rebooting the device.

Camera Configuration

- Remote Live View: Remotely viewing live video of the selected camera (s).
- Local Manual Operation: Locally starting/stopping manual recording, picture capturing and alarm output of the selected camera (s).
- Remote Manual Operation: Remotely starting/stopping manual recording, picture capturing and alarm output of the selected camera (s).
- Local Playback: Locally playing back recorded files of the selected camera (s).
- Remote Playback: Remotely playing back recorded files of the selected camera (s).
- Local PTZ Control: Locally controlling PTZ movement of the selected camera (s).
- Remote PTZ Control: Remotely controlling PTZ movement of the selected camera (s).
- Local Video Export: Locally exporting recorded files of the selected camera (s).



Local Camera Management is provided for the IP cameras only.

- (3) Click **OK** to save the settings and exit.

13.5.2 Deleting a User

Steps:

1. Enter the User Management interface.
Menu >Configuration>User
2. Select the user to be deleted from the list, as shown in Figure 13. 9.

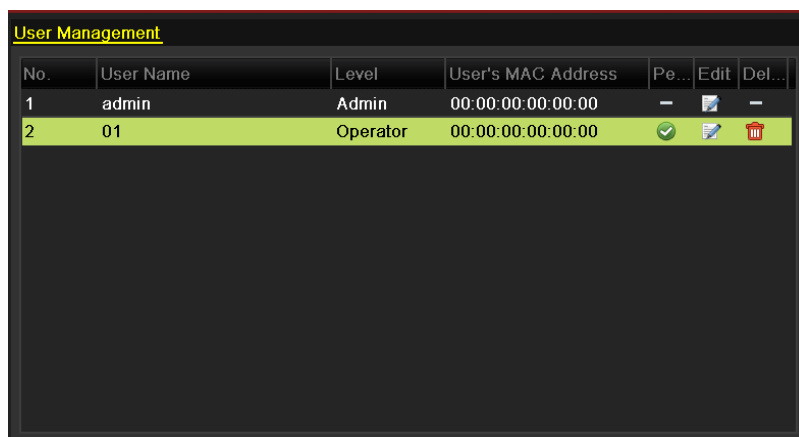



Figure 13. 9 User List

3. Click the  icon to delete the selected user account.

13.5.3 Editing a User

For the added user accounts, you can edit the parameters.

Steps:

1. Enter the User Management interface.
Menu >Configuration>User
2. Select the user to be edited from the list, as shown in Figure 13. 9.
3. Click the  icon to enter the Edit User interface, as shown in Figure 13. 10.

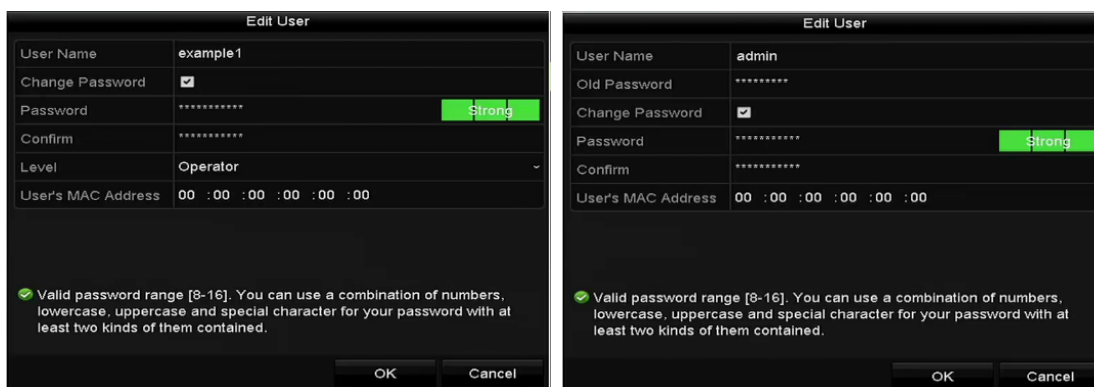



Figure 13. 10 Edit User Interface

4. Edit the corresponding parameters.
 - **Operator and Guest**
You can edit the user information, including user name, password, permission level and MAC address. Check the checkbox of **Change Password** if you want to change the password, and input the new password in the text field of **Password** and **Confirm**. A strong password is recommended.
 - **Admin**
You are only allowed to edit te password and MAC address. Check the checkbox of **Change Password** if you want to change the password, and the input the correct old password, and the new password in the text field of **Password** and **Confirm**.



STRONG PASSWORD RECOMMENDED– *We highly recommend you create a strong password of your own choosing (using a minimum of 8 characters, including upper case letters, lower case letters, numbers, and special characters) in order to increase the security of your product. And we recommend you reset your password regularly, especially in the high security system, resetting the password monthly or weekly can better protect your product.*

5. Click the **OK** button to save the settings and exit the menu.
6. For the **Operator** or **Guest** user account, you can also click the  button on the user management interface to edit the permission.

Appendix

Specifications

DS-7104HGHI-SH

Model		DS-7104HGHI-SH
Video/Audio input	Video compression	H.264
	Analog and HD-TVI video input	4-ch BNC interface (1.0Vp-p, 75 Ω)
	Supported camera types	720p/25, 720p/30, 720p/50, 720p/60, 1080p/25, 1080p/30, CVBS
	Audio compression	G.711u
	Audio input / Two-way audio in	1-ch, RCA (2.0 Vp-p, 1 KΩ)
	Video/Audio output	HDMI / VGA output
Encoding resolution		Main stream: 1080p (non-real-time)/720p/VGA/WD1/4CIF/CIF
		Sub-stream: WD1 (non-real-time)/4CIF (non-real-time)/CIF/QCIF/QVGA
Frame rate		Main stream: 1/16 fps to real time frame rate
		Sub-stream: 1/16 fps to real time frame rate
Video bitrate		32 Kbps to 6 Mbps
Audio output		1-ch, RCA (Linear, 1KΩ)
Audio bitrate		64 Kbps
Dual-stream		Support
Stream type		Video, Video & Audio
Synchronous playback	4-ch	
Playback resolution	1080p/720p/VGA/WD1/4CIF/CIF/QVGA/QCIF	
Network management	Remote connections	128
	Network protocols	TCP/IP, PPPoE, DHCP, DNS, DDNS, NTP, SADP, SMTP, SNMP, NFS, iSCSI, UPnP™, HTTPS
Hard disk	SATA	1 SATA interface
	Capacity	Up to 6 TB capacity for each disk
External interface	Network interface	1; 10 M/100 M self-adaptive Ethernet interface
	USB interface	2 × USB 2.0
General	Power supply	12 VDC
	Consumption (without hard disks)	≤ 15W
	Working temperature	-10 °C to +55 °C (14 °F to 131 °F)
	Working humidity	10% to 90%
	Dimensions (W × D × H)	200 × 200 × 45 mm (7.9 × 7.9 × 1.8 inch)
	Weight (without hard disks)	≤ 0.8 Kg (1.8 lb)

DS-7104HQHI-SH

Model		DS-7104HQHI-SH
Video/Audio input	Video compression	H.264
	Analog and HD-TVI video input	4-ch BNC interface (1.0Vp-p, 75 Ω)
	Supported camera types	720p/25, 720p/30, 720p/50, 720p/60, 1080p/25, 1080p/30, CVBS
	Audio compression	G.711u
	Audio input / Two-way audio in	1-ch, RCA (2.0 Vp-p, 1 KΩ)
	Video/Audio output	HDMI / VGA output
Encoding resolution		Main stream: 1080P / 720P / VGA / WD1 / 4CIF / CIF
		Sub-stream: WD1 (non-real-time)/4CIF (non-real-time)/CIF/QCIF/QVGA
Frame rate		Main stream: 1/16 fps to real time frame rate
		Sub-stream: 1/16 fps to real time frame rate
Video bitrate		32 Kbps to 10 Mbps
Audio output		1-ch, RCA (Linear, 1KΩ)
Audio bitrate		64 Kbps
Dual-stream		Support
Stream type		Video, Video & Audio
Synchronous playback		4-ch
Playback resolution	1080p/720p/VGA/WD1/4CIF/CIF/QVGA/QCIF	
Network management	Remote connections	128
	Network protocols	TCP/IP, PPPoE, DHCP, EZVIZ Cloud P2P, DNS, DDNS, NTP, SADP, SMTP, SNMP, NFS, iSCSI, UPnP™, HTTPS
Hard disk	SATA	1 SATA interface
	Capacity	Up to 6 TB capacity for each disk
External interface	Network interface	1; 10 M/100 M self-adaptive Ethernet interface
	USB port	2 × USB 2.0
General	Power supply	12 VDC
	Consumption (without hard disks)	≤ 15 W
	Working temperature	-10 °C ~ +55 °C (14 °F ~ 131 °F)
	Working humidity	10% ~ 90%
	Dimensions (W × D × H)	200 × 200 × 45 mm (7.9 × 7.9 × 1.8 inch)
	Weight (without hard disks)	≤ 0.8 Kg (1.8 lb)

DS-7100HGHI-E1

Model		DS-7104HGHI-E1	DS-7108HGHI-E1	DS-7116HGHI-E1
Video/Audio input	Video compression	H.264		
	Analog and HD-TVI video input	4-ch	8-ch	16-ch
		BNC interface (1.0Vp-p, 75 Ω)		
	Supported camera types	720p/25, 720p/30, CVBS		
	Audio compression	G711u		
Audio input / Two-way audio in	1-ch, RCA (2.0 Vp-p, 1 KΩ)			
Video/Audio output	HDMI / VGA output	1920 × 1080/60 Hz, 1280 × 1024/60 Hz, 1280 × 720/60 Hz, 1024 × 768/60 Hz		
	Encoding resolution	Main stream: 720p/WD1/4CIF/VGA/CIF		
		Sub-stream: 2CIF(non-real-time)/CIF	Sub-stream: 4CIF (non-real-time)/2CIF(non-real-time)/CIF	
	Frame rate	1/16 fps to real time frame rate		
	Video bitrate	32 Kbps to 4 Mbps		
	Audio output	1-ch, RCA (Linear, 1KΩ)		
	Audio bitrate	64 Kbps		
	Dual-stream	Support		
	Stream type	Video, Video & Audio		
	Synchronous playback	4-ch	8-ch	16-ch
Playback resolution	720p/VGA/WD1/4CIF/CIF/QVGA/QCIF			
Network management	Remote connections	32	128	128
	Network protocols	TCP/IP, PPPoE, DHCP, EZVIZ Cloud P2P, DNS, DDNS, NTP, SADP, SMTP, SNMP, NFS, iSCSI, UPnP™, HTTPS		
Hard disk	SATA	1 SATA interface		
	Capacity	Up to 6 TB capacity for each disk		
External interface	Network interface	1; 10 M/100 M self-adaptive Ethernet interface		
	USB port	2 × USB2.0		
General	Power supply	12 VDC		
	Consumption (without hard disks)	≤8 W	≤12 W	≤20 W
	Working temperature	-10 °C to +55 °C (14 °F to 131 °F)		
	Working humidity	10% to 90%		
	Dimensions (W × D × H)	200 × 200 × 45mm (7.9 × 7.9 × 1.8 inch)		285 × 210 × 45 mm (11.2 × 8.3 × 1.8 inch)
	Weight (without hard disks)	≤ 0.8 Kg (1.8 lb)		≤ 1.2 Kg (2.6 lb)

DS-7100HGHI-F1

Model		DS-7104HGHI-F1	DS-7108HGHI-F1	DS-7116HGHI-F1
Video/Audio input	Video input	4-ch	8-ch	16-ch
		BNC interface (1.0Vp-p, 75 Ω)		
	Supported HDTV input	720p/25, 720p/30		
	Supported AHD input	720p/25, 720p/30, CVBS		
	Audio input/ Two-way audio input	1-ch , RCA (2.0 Vp-p, 1 KΩ)		
Video/Audio output	HDMI/VGA output	1-ch, 1920 × 1080/60Hz, 1280 × 1024/60Hz, 1280 × 720/60Hz, 1024 × 768/60Hz		
	Audio output	1-ch, RCA (Linear, 1 KΩ)		
Network management	Remote connections	32	128	128
	Network protocols	TCP/IP, PPPoE, DHCP, EZVIZ Cloud P2P, DNS, DDNS, NTP, SADP, SMTP, SNMP, NFS, iSCSI, UPnP™, HTTPS		
Encoding	Video compression standard	H.264		
	Encoding resolution	720p/WD1/4CIF/VGA/CIF		
	Frame rate	1/16 fps, real time frame rate		
	Video bitrate	32 Kbps to 4 Mbps		
	Stream type	Video & Audio/Video		
	Dual-stream	Support. Sub-stream resolution: CIF/QVGA/QCIF (real time)		
	Audio compression standard	G.711u		
	Audio bitrate	64 Kbps		
	Synchronous playback	4-ch	8-ch	16-ch
Hard disk	Type	1		
	Capacity	Up to 6 TB capacity for each disk		
External interface	Network interface	1; RJ-45 10M/100M self-adaptive Ethernet interface		
	USB interface	Rear panel: 2 × USB 2.0		
General	Power supply	12 VDC		
	Consumption (without hard disks)	≤ 8W	≤ 12W	≤ 20W
	Working temperature	-10°C to +55°C (14°F to 131°F)		
	Working humidity	10% to 90%		
	Dimensions (W × D × H)	200 × 200 × 45mm (7.9 × 7.9 × 1.8 inch)		285 × 210 × 45 mm (11.2 × 8.3 × 1.8 inch)
	Weight (without hard disks)	≤ 0.8 kg (1.8 lb)		≤ 1.2 kg (2.6 lb)

DS-7200HGHI-SH

Model		DS-7204HGHI-SH	DS-7208HGHI-SH	DS-7216HGHI-SH
Video/Audio input	Video compression	H.264		
	Analog and HD-TVI video input	4-ch	8-ch	16-ch
		BNC interface (1.0Vp-p, 75 Ω)		
	Supported camera types	720p/25, 720p/30, 720p/50, 720p/60, 1080p/25, 1080p/30, CVBS		
	IP video input	1-ch	2-ch	2-ch
		Up to 2.0MP resolution		
	Audio compression	G.711u		
Audio input / Two-way audio in	1-ch, RCA (2.0 Vp-p, 1 KΩ)			
Video/Audio output	HDMI / VGA output	1920 × 1080/60 Hz, 1280 × 1024/60 Hz, 1280 × 720/60 Hz, 1024 × 768/60 Hz		
	Encoding resolution	Main stream: 1080p (non-real-time)/720p/VGA/WD1/4CIF/CIF		
		Sub-stream: WD1 (non-real-time)/4CIF (non-real-time)/CIF/QCIF/QVGA		
	Frame rate	Main stream: 1/16 fps to real time frame rate		
		Sub-stream: 1/16 fps to real time frame rate		
	Video bitrate	32 Kbps to 6 Mbps		
	Audio output	1-ch, RCA (Linear, 1KΩ)		
	Audio bitrate	64 Kbps		
	Dual-stream	Support		
	Stream type	Video, Video & Audio		
Synchronous playback	4-ch	8-ch	16-ch	
Playback resolution	1080P/720P/VGA/WD1/4CIF/CIF/QVGA/QCIF			
Network management	Remote connections	128		
	Network protocols	TCP/IP, PPPoE, DHCP, EZVIZ Cloud P2P, DNS, DDNS, NTP, SADP, SMTP, SNMP, NFS, iSCSI, UPnP™, HTTPS		
Hard disk	SATA	1 SATA interface		2 SATA interfaces
	Capacity	Up to 6 TB capacity for each disk		
External interface	Network interface	1; 10 M/100 M self-adaptive Ethernet interface		1; 10 M/100 M/1000 M self-adaptive Ethernet interface
	Serial interface	1; standard RS-485 serial interface, half-duplex		
	USB port	2 × USB 2.0		
General	Power supply	12 VDC		
	Consumption (without hard disks)	≤ 15 W	≤ 20 W	≤ 30 W
	Working temperature	-10 °C to +55 °C (14 °F to 131 °F)		
	Working humidity	10% to 90%		
	Chassis	1U chassis		380 mm 1U chassis
	Dimensions (W × D × H)	315 × 242 × 45 mm (12.4 × 9.5 × 1.8 inch)		380 × 290 × 48 mm (15.0 × 11.4 × 1.9 inch)
	Weight (without hard disks)	≤ 1.5 Kg (3.3 lb)		≤ 2 Kg (4.4 lb)

DS-7200HQHI-SH

Model		DS-7204HQHI-SH	DS-7208HQHI-SH	DS-7216HQHI-SH
Video/Audio input	Video compression	H.264		
	Analog and HD-TVI video input	4-ch	8-ch	16-ch
		BNC interface (1.0Vp-p, 75 Ω)		
	Supported camera types	720p/25, 720p/30, 720p/50, 720p/60, 1080p/25, 1080p/30, CVBS		
	IP video input	2-ch		
		Up to 1080P resolution		
	Audio compression	G.711u		
Video/Audio output	Audio input	4-ch, RCA (2.0 Vp-p, 1 KΩ)		
	Two-way audio in	1-ch, RCA (2.0 Vp-p, 1 KΩ) (using the 1 st channel of audio input)		
	HDMI / VGA output	1920 × 1080/60 Hz, 1280 × 1024/60 Hz, 1280 × 720/60 Hz, 1024 × 768/60 Hz		
	Encoding resolution	Main stream: 1080p/720p/VGA/WD1/4CIF/CIF Sub-stream: WD1 (non-real-time)/4CIF(non-real-time)/CIF/QCIF/QVGA		
	Frame rate	Main stream: 1/16 fps to real time frame rate Sub-stream: 1/16 fps to real time frame rate		
	Video bitrate	32 Kbps to 10 Mbps		
	Audio output	1-ch, RCA (Linear, 1KΩ)		
Network management	Audio bitrate	64 Kbps		
	Dual-stream	Support		
	Stream type	Video, Video & Audio		
	Synchronous playback	4-ch	8-ch	16-ch
	Playback resolution	1080p/720p/VGA/WD1/4CIF/CIF/QVGA/QCIF		
	Remote connections	128		
	Network protocols	TCP/IP, PPPoE, DHCP, EZVIZ Cloud P2P, DNS, DDNS, NTP, SADP, SMTP, SNMP, NFS, iSCSI, UPnP™, HTTPS		
Hard disk	SATA	1 SATA interface	2 SATA interfaces	
	Capacity	Up to 6 TB capacity for each disk		
External interface	Network interface	1; 10 M/100 M/1000M self-adaptive Ethernet interface		
	Serial interface	1; standard RS-485 serial interface, half-duplex		
	Alarm in/out	4/1	8/4	16/4
	USB port	2 × USB2.0		
General	Power supply	12 VDC		
	Consumption (without hard disks)	≤ 15 W	≤ 30 W	≤ 45 W
	Working temperature	-10 °C to +55 °C (14 °F to 131 °F)		
	Working humidity	10% to 90%		
	Chassis	1U chassis	380 mm 1U chassis	
	Dimensions (W × D × H)	315 × 242 × 45 mm (12.4 × 9.5 × 1.8 inch)	380 × 290 × 48 mm (15.0 × 11.4 × 1.9 inch)	
	Weight (without hard disks)	≤ 1.5 Kg (3.3 lb)	≤ 2 Kg (4.4 lb)	

DS-7200HGHI-E1

Model		DS-7204HGHI-E1	DS-7208HGHI-E1	DS-7216HGHI-E1
Video/Audio input	Video compression	H.264		
	Analog and HD-TVI video input	4-ch	8-ch	16-ch
		BNC interface (1.0Vp-p, 75 Ω)		
	Supported camera types	720P/25, 720P/30, CVBS		
	IP video input	1-ch	2-ch	2-ch
		Up to 720p resolution	Up to 1080P resolution	
	Audio compression	G.711u		
Audio input / Two-way audio in	1-ch, RCA (2.0 Vp-p, 1 KΩ)			
Video/Audio output	HDMI / VGA output	1920 × 1080/60 Hz, 1280 × 1024/60 Hz, 1280 × 720/60 Hz, 1024 × 768/60 Hz		
	Encoding resolution	Main stream: 720p/VGA/WD1/4CIF/CIF		
		Sub-stream: 2CIF (non-real-time)/CIF	Sub-stream: 4CIF (non-real-time)/2CIF (non-real-time)/CIF	
	Frame rate	1/16 fps ~ Real time frame rate		
	Video bitrate	32 Kbps ~ 4 Mbps		
	Audio output	1-ch, RCA (Linear, 1KΩ)		
	Audio bitrate	64 Kbps		
	Dual-stream	Support		
	Stream type	Video, Video & Audio		
	Synchronous playback	4-ch	8-ch	16-ch
Playback resolution	720p/VGA/WD1/4CIF/CIF/QVGA/QCIF			
Network management	Remote connections	32	128	128
	Network protocols	TCP/IP, PPPoE, DHCP, EZVIZ Cloud P2P, DNS, DDNS, NTP, SADP, SMTP, SNMP, NFS, iSCSI, UPnP™, HTTPS		
Hard disk	SATA	1 SATA interface		
	Capacity	Up to 6 TB capacity for each disk		
External interface	Network interface	1; 10M/100M self-adaptive Ethernet interface		
	USB port	2 × USB2.0		
General	Power supply	12 VDC		
	Consumption (without hard disks)	≤ 8 W	≤ 12 W	≤ 20 W
	Working temperature	-10 °C to +55 °C (14 °F to 131 °F)		
	Working humidity	10% to 90%		
	Chassis	1U chassis		
	Dimensions (W × D × H)	260 × 222 × 45 mm (10.2 × 8.7 × 1.8 inch)		
	Weight (without hard disks)	≤ 1 Kg (2.2 lb)		≤ 1.2 Kg (2.6 lb)

DS-7200HGHI-E2

Model		DS-7208HGHI-E2	DS-7216HGHI-E2
Video/Audio input	Video compression	H.264	
	Analog and HD-TVI video input	8-ch	16-ch
		BNC interface (1.0Vp-p, 75 Ω)	
	Supported camera types	720p/25, 720p/30, CVBS	
	IP video input	2-ch	2-ch
		Up to 1080p resolution	
	Audio compression	G.711u	
Audio input / Two-way audio in	1-ch, RCA (2.0 Vp-p, 1 KΩ)		
Video/Audio output	HDMI / VGA output	1920 × 1080/60 Hz, 1280 × 1024/60 Hz, 1280 × 720/60 Hz, 1024 × 768/60 Hz	
	Encoding resolution	Main stream: 720P/WD1/4CIF/VGA/CIF	
		Sub-stream: 4CIF (non-real-time)/2CIF (non-real-time)/CIF	
	Frame rate	1/16 fps to real time frame rate	
	Video bitrate	32 Kbps to 4 Mbps	
	Audio output	1-ch, RCA (Linear, 1KΩ)	
	Audio bitrate	64 Kbps	
	Dual-stream	Support	
	Stream type	Video, Video & Audio	
	Synchronous playback	8-ch	16-ch
Playback resolution: 720P/VGA/WD1/4CIF/CIF/QVGA/QCIF			
Network management	Remote connections	128	
	Network protocols	TCP/IP, PPPoE, DHCP, EZVIZ Cloud P2P, DNS, DDNS, NTP, SADP, SMTP, SNMP, NFS, iSCSI, UPnP™, HTTPS	
Hard disk	SATA	2 SATA interfaces	
	Capacity	Up to 6 TB capacity for each disk	
External interface	Network interface	1; 10 M/100 M self-adaptive Ethernet interface	
	USB port	2 × USB2.0	
General	Power supply	12 VDC	
	Consumption (without hard disks)	≤ 12 W	≤ 20 W
	Working temperature	-10 °C to +55 °C (14 °F to 131 °F)	
	Working humidity	10% to 90%	
	Chassis	1U chassis	
	Dimensions (W × D × H)	380 × 320 × 45 mm (14.9 × 12.6 × 1.8 inch)	
	Weight (without hard disks)	≤ 2 kg (4.4 lb)	

DS-7200HQHI-E1/E2

Model		DS-7204HQHI-E1	DS-7208HQHI-E1	DS-7216HQHI-E2
Video/Audio input	Video compression	H.264		
	Analog and HD-TVI video input	4-ch	8-ch	16-ch
		BNC interface (1.0Vp-p, 75 Ω)		
	Supported camera types	1080p/30, 1080p/25, 720p/60, 720p/50,720p/30,720p/25, CVBS		
	IP video input	1-ch	2-ch	2-ch
		Up to 2.0 MP resolution		
	Audio compression	G711u		
Audio input/Two-way audio in	1-ch, RCA (2.0 Vp-p, 1 KΩ)			
Video/Audio output	HDMI/VGA output	1920 × 1080/60 Hz, 1280 × 1024/60 Hz, 1280 × 720/60 Hz, 1024 × 768/60 Hz		
	CVBS output	1-ch, BNC (1.0 Vp-p, 75 Ω), resolution: PAL: 704 × 576, NTSC: 704 × 480		
	Encoding resolution	Main stream: 1080p lite (real-time)/720p/VGA/WD1/4CIF/CIF		
		Sub-stream: WD1 (non-real-time)/4CIF (non-real-time)/CIF/QCIF/QVGA		
	Frame rate	Main stream: 1/16 fps to real time frame rate		
		Sub-stream: 1/16 fps to real time frame rate		
	Video bitrate	32 Kbps to 6 Mbps		
	Audio output	1-ch, RCA (Linear, 1KΩ)		
	Audio bitrate	64 Kbps		
	Dual-stream	Support		
	Stream type	Video, Video & Audio		
	Synchronous playback	4-ch	8-ch	16-ch
Playback resolution	1080p/720p/VGA/WD1/4CIF/CIF/QVGA/QCIF			
Network management	Remote connections	128		
	Network protocols	TCP/IP, PPPoE, DHCP, EZVIZ Cloud P2P, DNS, DDNS, NTP, SADP, SMTP, SNMP, NFS, iSCSI, UPnP™, HTTPS		
Hard disk	SATA	1 SATA interface		2 SATA interfaces
	Capacity	Up to 6TB capacity for each disk		
External interface	Network interface	1; 10M/100M self-adaptive Ethernet interface		1; 10M/100M/1000M self-adaptive Ethernet interface
	Serial interface	1; RS-485 serial interface, half-duplex		
	USB interface	2 × USB2.0		
General	Power supply	12 VDC		
	Consumption (without hard disks)	≤ 15 W	≤ 20 W	≤ 30 W
	Working temperature	-10 °C to +55 °C (14 °F to 131 °F)		
	Working humidity	10% to 90%		
	Chassis	1U chassis		380 mm chassis
	Dimensions (W × D × H)	315 × 242 × 45 mm (12.4 × 9.5 × 1.8 inch)		380 × 320 × 45 mm (15.0 × 12.6 × 1.8 inch)
	Weight (without hard disks)	≤ 1.5Kg (3.3lb)		≤ 2Kg (4.4lb)

DS-7200HGHI-F1

Model		DS-7204HGHI-F1	DS-7208HGHI-F1	DS-7216HGHI-F1
Video/Audio input	Analog video input	4-ch	8-ch	16-ch
		BNC interface (1.0Vp-p, 75 Ω)		
	Supported HD TVI input	720p/25, 720p/30		
	Supported AHD input	720p/25, 720p/30, CVBS		
	IP video input	1-ch	2-ch	2-ch
		Up to 960p resolution	Up to 1080p resolution	
Audio input/ Two-way audio input	1-ch, RCA (2.0 Vp-p, 1 KΩ)			
Video/Audio output	HDMI/VGA output	1-ch, 1920 × 1080/60Hz, 1280 × 1024/60Hz, 1280 × 720/60Hz, 1024 × 768/60Hz		
	Audio output	1-ch, RCA (Linear, 1 KΩ)		
Network management	Remote connections	32	128	128
	Network protocols	TCP/IP, PPPoE, DHCP, EZVIZ Cloud P2P, DNS, DDNS, NTP, SADP, SMTP, SNMP, NFS, iSCSI, UPnP™, HTTPS		
Encoding	Video compression standard	H.264		
	Encoding resolution	720p/WD1/4CIF/VGA/CIF		
	Frame rate	1/16 fps, real time frame rate		
	Video bitrate	32 Kbps to 4 Mbps		
	Stream type	Video & Audio/Video		
	Dual-stream	Support.		
	Audio compression standard	G.711u		
	Audio bitrate	64 Kbps		
	Synchronous playback	4-ch	8-ch	16-ch
Hard disk	Type	1		
	Capacity	Up to 6 TB capacity for each disk		
External interface	Network interface	1; RJ-45 10M/100M self-adaptive Ethernet interface		
	USB interface	Rear panel: 2 × USB 2.0		
General	Power supply	12 VDC		
	Consumption (without hard disks)	≤ 8W	≤ 12W	≤ 20W
	Working temperature	-10°C to +55°C (14°F to 131°F)		
	Working humidity	10% to 90%		
	Chassis	260 mm chassis		
	Dimensions (W × D × H)	260 × 222 × 45mm (10.2 × 8.7 × 1.8 inch)		
	Weight (without hard disks)	≤ 1 Kg (2.2 lb)		≤ 1.2 Kg (2.6 lb)

DS-7200HGHI-F2

Model		DS-7208HGHI-F2	DS-7216HGHI-F2	
Video/Audio input	Analog video input	8-ch	16-ch	
		BNC interface (1.0Vp-p, 75 Ω)		
	HD TVI input	720p/25, 720p/30		
	AHD input	720p/25, 720p/30, CVBS		
	IP video input	2-ch	2-ch	
		Up to 1080p resolution		
Audio input/Two-way audio input	1-ch			
	RCA (2.0 Vp-p, 1 KΩ)			
Video/Audio output	HDMI/VGA output	1-ch, 1920 × 1080/60Hz, 1280 × 1024/60Hz, 1280 × 720/60Hz, 1024 × 768/60Hz		
	Audio output	1-ch, RCA (Linear, 1 KΩ)		
Encoding	Video compression standard	H.264		
	Encoding resolution	720p/WD1/4CIF/VGA/CIF		
	Frame rate	1/16 fps, real time frame rate		
	Video bitrate	32 Kbps to 4 Mbps		
	Stream type	Video & Audio/Video		
	Dual-stream	Support.		
	Audio compression standard	G711u		
	Audio bitrate	64 Kbps		
	Synchronous playback	8-ch	16-ch	
Network management	Remote connections	128		
	Network protocols	TCP/IP, PPPoE, DHCP, EZVIZ Cloud P2P, DNS, DDNS, NTP, SADP, SMTP, SNMP, NFS, iSCSI, UPnP™, HTTPS		
Hard disk	Type	2		
	Capacity	Up to 6 TB capacity for each disk		
External interface	Network interface	1; RJ-45 10M/100M self-adaptive Ethernet interface		
	USB interface	Rear panel: 2 × USB 2.0		
General	Power supply	12 VDC		
	Consumption (without hard disks)	≤ 12W	≤ 20W	
	Working temperature	-10°C to +55°C (14°F to 131°F)		
	Working humidity	10% to 90%		
	Chassis	380 mm 1U chassis		
	Dimensions (W × D × H)	380 × 320 × 48 mm (14.9 × 12.6 × 1.9 inch)		
	Weight (without hard disks)	≤ 2 kg (4.4 lb)		

DS-7300HGHI-SH

Model		DS-7304HGHI-SH	DS-7308HGHI-SH	DS-7316HGHI-SH	
Video/Audio input	Video compression	H.264			
	Analog and HD-TVI video input	4-ch	8-ch	16-ch	
	Supported camera types	BNC interface (1.0Vp-p, 75 Ω)			
	IP video input	720p/25, 720p/30, 720p/50, 720p/60, 1080p/25, 1080p/30, CVBS			
	IP video input	1-ch (up to 5-ch)	2-ch (up to 10-ch)	2-ch (up to 18-ch)	
		Up to 2MP resolution			
	Audio compression	G.711u			
	Audio input	4-ch, RCA (2.0 Vp-p, 1 KΩ)			
Two-way audio in	1-ch, RCA (2.0 Vp-p, 1 KΩ)				
Video/Audio output	HDMI / VGA output	1920 × 1080/60 Hz, 1280 × 1024/60 Hz, 1280 × 720/60 Hz, 1024 × 768/60 Hz			
	CVBS output	1-ch, BNC (1.0 Vp-p, 75 Ω), resolution: PAL: 704 × 576, NTSC: 704 × 480			
	Encoding resolution	Main stream: 1080p (non-real-time)/720P/VGA/4CIF/CIF			
		Sub-stream: WD1 (non-real-time)/4CIF(non-real-time)/CIF/QCIF/QVGA			
	Frame rate	Main stream: 1/16 fps to real time frame rate			
		Sub-stream: 1/16 fps to real time frame rate			
	Video bitrate	32 Kbps to 6 Mbps			
	Audio output	2-ch, RCA (Linear, 1KΩ, for VGA output and CVBS output respectively)			
	Audio bitrate	64 Kbps			
	Dual-stream	Support			
	Stream type	Video, Video & Audio			
Synchronous playback	4-ch	8-ch	16-ch		
Playback resolution	1080p/720p/VGA/WD1/4CIF/CIF/QVGA/QCIF				
Network management	Remote connection	128			
	Network protocols	TCP/IP, PPPoE, DHCP, EZVIZ Cloud P2P, DNS, DDNS, NTP, SADP, SMTP, SNMP, NFS, iSCSI, UPnP™, HTTPS			
Hard disk	Type	4 SATA interfaces for 4 HDDs; 1 eSATA interface			
	Capacity	Up to 6 TB capacity for each disk			
External interface	Network interface	1; 10 M/100 M/1000 M self-adaptive Ethernet interface			
	Serial interface	RS-232, RS-485, Keyboard			
	USB port	3 × USB2.0			
	Alarm in / out	16/4			
General	Power supply	100 to 240 VAC, 47 to 63 Hz			
	Consumption (without hard disks)	≤ 30 W	≤ 40 W	≤ 55 W	
	Working temperature	-10 °C to +55 °C (14 °F to 131 °F)			
	Working humidity	10% to 90%			
	Chassis	19-inch rack-mounted 1.5U chassis			
	Dimensions (W × D × H)	445 × 390 × 70 mm (17.5 × 15.3 × 2.7 inch)			
	Weight (without hard disks)	≤ 5 Kg (11.0 lb)			

DS-7324/7332HGHI-SH

Model		DS-7324HGHI-SH	DS-7332HGHI-SH	
Video/ Audio input	Video compression	H.264		
	Analog and HD-TVI video input	24-ch	32-ch	
		BNC interface (1.0Vp-p, 75 Ω)		
	Supported camera types	720p/25, 720p/30, 720p/50, 720p/60, 1080p/25, 1080p/30, CVBS		
	IP video input	8-ch (up to 32-ch)	8-ch (up to 32-ch)	
		Up to 2 MP resolution		
	Audio compression	G711u		
	Audio input	4-ch, RCA (2.0 Vp-p, 1 KΩ)		
Two-way audio in	1-ch, RCA (2.0 Vp-p, 1 KΩ)			
Video/ Audio output	HDMI / VGA output	1920 × 1080/60 Hz, 1280 × 1024/60 Hz, 1280 × 720/60 Hz, 1024 × 768/60 Hz		
	Encoding resolution	Main stream: 1080P (non-real-time)/720p/WD1/VGA/4CIF/CIF		
		Sub-stream: WD1 (non-real-time)/4CIF (non-real-time)/CIF/QCIF/QVGA		
	Frame rate	Main stream: 1/16 fps to real time frame rate		
		Sub-stream: 1/16 fps to real time frame rate		
	Video bitrate	32 Kbps to 6 Mbps		
	Audio output	1-ch, RCA (Linear, 1KΩ)		
	Audio bitrate	64 Kbps		
	Dual-stream	Support		
	Stream type	Video, Video & Audio		
Synchronous playback	24-ch	32-ch		
Playback resolution	1080p/720p/VGA/WD1/4CIF/CIF/QVGA/QCIF			
Network management	Remote connection	128		
	Network protocols	TCP/IP, PPPoE, DHCP, EZVIZ Cloud P2P, DNS, DDNS, NTP, SADP, SMTP, SNMP, NFS, iSCSI, UPnP™, HTTPS		
Hard disk	Type	4 SATA interfaces for 4 HDDs; 1 eSATA interface		
	Capacity	Up to 6TB capacity for each disk		
External interface	Network interface	1; 10 M/100 M/1000 M self-adaptive Ethernet interface		
	Serial interface	RS-232, RS-485, Keyboard		
	USB port	3 × USB2.0		
	Alarm in / out	16/4		
General	Power supply	100 to 240 VAC, 47 to 63 Hz		
	Consumption (without hard disks)	≤ 55 W	≤ 65 W	
	Working temperature	-10 °C to +55 °C (14 °F to 131 °F)		
	Working humidity	10% to 90%		
	Chassis	19-inch rack-mounted 1.5U chassis		
	Dimensions (W × D × H)	445 × 390 × 70 mm (17.5 × 15.3 × 2.7 inch)		
	Weight (without hard disks)	≤ 5 Kg (11 lb)		

DS-7300HQHI-SH

Model		DS-7304HQHI-SH	DS-7308HQHI-SH	DS-7316HQHI-SH
Video/Audio input	Video compression	H.264		
	Analog and HD-TVI video input	4-ch (up to 6-ch)	8-ch (up to 10-ch)	16-ch (up to 18-ch)
		BNC interface (1.0Vp-p, 75 Ω)		
	Supported camera types	720p/25, 720p/30, 720p/50, 720p/60, 1080p/25, 1080p/30, CVBS		
	IP video input	2-ch Up to 2 MP resolution		
	Audio compression	G.711u		
	Audio input	4-ch, RCA (2.0 Vp-p, 1 KΩ)		
	Two-way audio in	1-ch, RCA (2.0 Vp-p, 1 KΩ)		
Video/Audio output	HDMI / VGA output	1920 × 1080/60 Hz, 1280 × 1024/60 Hz, 1280 × 720/60 Hz, 1024 × 768/60 Hz		
	CVBS output	1-ch, BNC (1.0 Vp-p, 75 Ω), resolution: PAL: 704 × 576, NTSC: 704 × 480		
	Encoding resolution	Main stream: 1080p/720p/VGA/4CIF/CIF Sub-stream: WD1 (non-real-time)/4CIF(non-real-time)/CIF/QCIF/QVGA		
	Frame rate	Main stream: 1/16 fps to real time frame rate Sub-stream: 1/16 fps to real time frame rate		
	Video bitrate	32 Kbps to 10 Mbps		
	Audio output	2-ch, RCA (Linear, 1KΩ, for VGA output and CVBS output respectively)		
	Audio bitrate	64 Kbps		
	Dual-stream	Support		
	Stream type	Video, Video & Audio		
	Synchronous playback	4-ch	8-ch	16-ch
	Playback resolution	1080p/720p/VGA/WD1/4CIF/CIF/QVGA/QCIF		
Network management	Remote connection	128		
	Network protocols	TCP/IP, PPPoE, DHCP, EZVIZ Cloud P2P, DNS, DDNS, NTP, SADP, SMTP, SNMP, NFS, iSCSI, UPnP™, HTTPS		
Hard disk	Type	4 SATA interfaces for 4 HDDs; 1 eSATA interface		
	Capacity	Up to 6 TB capacity for each disk		
External interface	Network interface	1; 10 M/100 M/1000 M self-adaptive Ethernet interface		
	Serial interface	RS-232, RS-485, Keyboard		
	USB port	3 × USB2.0		
	Alarm in / out	16/4		
General	Power supply	100 to 240 VAC, 47 to 63 Hz		
	Consumption (without hard disks)	≤ 30 W	≤ 40 W	≤ 55 W
	Working temperature	-10 °C to +55 °C (14 °F to 131 °F)		
	Working humidity	10% to 90%		
	Chassis	19-inch rack-mounted 1.5U chassis		
	Dimensions (W × D × H)	445 × 390 × 70 mm (17.5 × 15.3 × 2.7 inch)		
	Weight (without hard disks)	≤ 5Kg (11 lb)		

DS-8100HGHI-SH

Model		DS-8104HGHI-SH	DS-8108HGHI-SH	DS-8116HGHI-SH
Video/Audio input	Video compression	H.264		
	Analog and HD-TVI video input	4-ch	8-ch	16-ch
		BNC interface (1.0Vp-p, 75 Ω)		
	Supported camera types	720p/25, 720p/30, 720p/50, 720p/60, 1080p/25, 1080p/30, CVBS		
	IP video input	1-ch	2-ch	2-ch
		Up to 2 MP resolution		
	Audio compression	G.711u		
	Audio input	4-ch	8-ch	16-ch
RCA (2.0 Vp-p, 1 KΩ)				
Two-way audio in	1-ch, RCA (2.0 Vp-p, 1 KΩ)			
Video/Audio output	HDMI / VGA output	1920 × 1080/60 Hz, 1280 × 1024/60 Hz, 1280 × 720/60 Hz, 1024 × 768/60 Hz		
	CVBS output	1-ch, BNC (1.0 Vp-p, 75 Ω), resolution: PAL: 704 × 576, NTSC: 704 × 480		
	Encoding resolution	Main stream: 1080P (non-real-time)/720p/WD1/VGA/4CIF/CIF		
		Sub-stream: WD1 (non-real-time)/4CIF (non-real-time)/CIF/QCIF/QVGA		
	Frame rate	Main stream: 1/16 fps to real time frame rate		
		Sub-stream: 1/16 fps to real time frame rate		
	Video bitrate	32 Kbps to 6 Mbps		
	Audio output	2-ch, RCA (Linear, 1KΩ, for VGA output and CVBS output respectively)		
	Audio bitrate	64 Kbps		
	Dual-stream	Support		
	Stream type	Video, Video & Audio		
Synchronous playback	4-ch	8-ch	16-ch	
Playback resolution	1080p/720p/VGA/WD1/4CIF/CIF/QVGA/QCIF			
Network management	Remote connection	128		
	Network protocols	TCP/IP, PPPoE, DHCP, EZVIZ Cloud P2P, DNS, DDNS, NTP, SADP, SMTP, SNMP, NFS, iSCSI, UPnP™, HTTPS		
Hard disk	Type	8 SATA interfaces for 8 HDDs; 1 eSATA interface		
	Capacity	Up to 6 TB capacity for each disk		
External interface	Network interface	2; 10 M/100 M/1000 M self-adaptive Ethernet interfaces		
	Serial interface	RS-232, RS-485, Keyboard;		
	USB port	3 × USB 2.0		
	Alarm in / out	16/4		
General	Power supply	100 to 240 VAC, 47 to 63 Hz		
	Consumption (without hard disks)	≤ 30 W	≤ 40 W	≤ 55 W
	Working temperature	-10 °C to +55 °C (14 °F to 131 °F)		
	Working humidity	10% to 90%		
	Chassis	19-inch rack-mounted 2U chassis		
	Dimensions (W × D × H)	445 × 470 × 90 mm (17.5 × 18.5 × 3.5 inch)		
	Weight (without hard disks)	≤ 8 Kg (17.6 lb)		

DS-8124/8132HGHI-SH

Model		DS-8124HGHI-SH	DS-8132HGHI-SH	
Video/Audio input	Video compression	H.264		
	Analog and HD-TVI video input	24-ch	32-ch	
		BNC interface (1.0Vp-p, 75 Ω)		
	Supported camera types	720p/25, 720p/30, 720p/50, 720p/60, 1080p/25, 1080p/30, CVBS		
	IP video input	16-ch (up to 32-ch)	16-ch (up to 32-ch)	
		Up to 2 MP resolution		
	Audio compression	G.711u		
	Audio input	16-ch	16-ch	
RCA (2.0 Vp-p, 1 KΩ)				
Two-way audio in	1-ch, RCA (2.0 Vp-p, 1 KΩ)			
Video/Audio output	HDMI 1/ VGA and HDMI2 output	1920 × 1080/60 Hz, 1280 × 1024/60 Hz, 1280 × 720/60 Hz, 1024 × 768/60 Hz		
	Encoding resolution	Main stream: 1080p(non-real-time)/720p/WD1/VGA/4CIF/CIF		
		Sub-stream: WD1 (12 fps)/4CIF (12fps)/CIF/QCIF/QVGA		
	Frame rate	Main stream: 1/16 fps to real time frame rate		
		Sub-stream: 1/16 fps to real time frame rate		
	Video bitrate	32 Kbps to 6 Mbps		
	Audio output	1-ch, RCA (Linear, 1KΩ)		
	Audio bitrate	64 Kbps		
	Dual-stream	Support		
	Stream type	Video, Video & Audio		
Synchronous playback	24-ch	32-ch		
Playback resolution	1080p/720p/VGA/WD1/4CIF/CIF/QVGA/QCIF			
Network management	Remote connection	128		
	Network protocols	TCP/IP, PPPoE, DHCP, EZVIZ Cloud P2P, DNS, DDNS, NTP, SADP, SMTP, SNMP, NFS, iSCSI, UPnP™, HTTPS		
Hard disk	Type	8 SATA interfaces for 8 HDDs; 1 eSATA interface		
	Capacity	Up to 6TB capacity for each disk		
External interface	Network interface	2; 10 M/100 M/1000 M self-adaptive Ethernet interfaces		
	Serial interface	RS-232, RS-485, Keyboard;		
	USB port	3 × USB 2.0		
	Alarm in / out	16/8		
General	Power supply	100 to 240 VAC, 47 to 63 Hz		
	Consumption (without hard disks)	≤ 60 W	≤ 67 W	
	Working temperature	-10 °C to +55 °C (14 °F to 131 °F)		
	Working humidity	10% to 90%		
	Chassis	19-inch rack-mounted 2U chassis		
	Dimensions (W × D × H)	445 × 470 × 90 mm (17.5 × 18.5 × 3.5 inch)		
	Weight (without hard disks)	≤8 Kg (17.6 lb)		

DS-8100HQHI-SH

Model		DS-8104HQHI-SH	DS-8108HQHI-SH	DS-8116HQHI-SH
Video/Audio input	Video compression	H.264		
	Analog and HD-TVI video input	4-ch	8-ch	16-ch
		BNC interface (1.0Vp-p, 75 Ω)		
	Supported camera types	720p/25, 720p/30, 720p/50, 720p/60, 1080p/25, 1080p/30, CVBS		
	IP video input	2-ch (up to 6-ch)	2-ch (up to 10-ch)	2-ch (up to 18-ch)
		Up to 2 MP resolution		
	Audio compression	G.711u		
	Audio input	4-ch	8-ch	16-ch
RCA (2.0 Vp-p, 1 KΩ)				
Two-way audio in	1-ch, RCA (2.0 Vp-p, 1 KΩ)			
Video/Audio output	HDMI / VGA output	1920 × 1080/60 Hz, 1280 × 1024/60 Hz, 1280 × 720/60 Hz, 1024 × 768/60 Hz		
	CVBS output	1-ch, BNC (1.0 Vp-p, 75 Ω), resolution: PAL: 704 × 576, NTSC: 704 × 480		
	Encoding resolution	Main stream: 1080p/720p/WD1/VGA/4CIF/CIF		
		Sub-stream: WD1 (non-real-time)/4CIF (non-real-time)/CIF/QCIF/QVGA		
	Frame rate	Main stream: 1/16 fps to real time frame rate		
		Sub-stream: 1/16 fps to real time frame rate		
	Video bitrate	32 Kbps to 10 Mbps		
	Audio output	2-ch, RCA (Linear, 1KΩ, for VGA output and CVBS output respectively)		
	Audio bitrate	64 Kbps		
	Dual-stream	Support		
	Stream type	Video, Video & Audio		
Synchronous playback	4-ch	8-ch	16-ch	
Playback resolution	1080p/720p/VGA/WD1/4CIF/CIF/QVGA/QCIF			
Network management	Remote connection	128		
	Network protocols	TCP/IP, PPPoE, DHCP, EZVIZ Cloud P2P, DNS, DDNS, NTP, SADP, SMTP, SNMP, NFS, iSCSI, UPnP™, HTTPS		
Hard disk	Type	8 SATA interfaces for 8 HDDs; 1 eSATA interface		
	Capacity	Up to 6 TB capacity for each disk		
External interface	Network interface	2; 10 M/100 M/1000 M self-adaptive Ethernet interfaces		
	Serial interface	RS-232, RS-485, Keyboard;		
	USB port	3 × USB 2.0		
	Alarm in / out	16/4		
General	Power supply	100 to 240 VAC, 47 to 63 Hz		
	Consumption (without hard disks)	≤ 35 W	≤ 45 W	≤ 65 W
	Working temperature	-10 °C to +55 °C (14 °F to 131 °F)		
	Working humidity	10% to 90%		
	Chassis	19-inch rack-mounted 2U chassis		
	Dimensions (W × D × H)	445 × 470 × 90 mm (17.5 × 18.5 × 3.5 inch)		
	Weight (without hard disks)	≤ 8 Kg (17.6 lb)		

DS-9000HQHI-SH

Model		DS-9004HQHI-SH	DS-9008HQHI-SH	DS-9016HQHI-SH
Video/Audio input	Video compression	H.264		
	Analog and HD-TVI video input	4-ch	8-ch	16-ch
		BNC interface (1.0Vp-p, 75 Ω)		
	Supported camera types	720p/25Hz, 720p/30 Hz, 720p/50 Hz, 720p/60 Hz, 1080p/25 Hz, 1080p/30 Hz, CVBS		
	IP video input	6-ch (up to 10-ch)	10-ch (up to 18-ch)	18-ch (up to 32-ch)
		Up to 5 MP resolution		
	Audio compression	G.711u		
Audio input	4-ch	8-ch	16-ch	
	RCA (2.0 Vp-p, 1 KΩ)			
Two-way audio in	1-ch, RCA (2.0 Vp-p, 1 KΩ)			
Network	Incoming bandwidth	110 Mbps	160 Mbps	260 Mbps
	Remote connection	128		
	Network protocols	TCP/IP, PPPoE, DHCP, EZVIZ Cloud P2P, DNS, DDNS, NTP, SADP, SMTP, SNMP, NFS, iSCSI, UPnP™, HTTPS		
Video/Audio output	HDMI output	1-ch (HDMI/VGA)	1-ch	
		1920 × 1080/60 Hz, 1280 × 1024/60 Hz, 1280 × 720/60 Hz, 1024 × 768/60 Hz		
	VGA output	1-ch (HDMI/VGA)	1-ch	
		1920 × 1080/60 Hz, 1280 × 1024/60 Hz, 1280 × 720/60 Hz, 1024 × 768/60 Hz		
	CVBS output	1-ch, BNC (1.0 Vp-p, 75 Ω), resolution: PAL: 704 × 576, NTSC: 704 × 480		
	Encoding resolution	Main stream: 1080p/720p/WD1/VGA/4CIF/CIF		
		Sub-stream: WD1 (non-real-time)/4CIF(non-real-time)/CIF/QCIF/QVGA		
	Frame rate	Main stream: 1/16 fps to real time frame rate		
		Sub-stream: 1/16 fps to real time frame rate		
	Video bitrate	32 Kbps to 10 Mbps		
	Audio output	2-ch, RCA (Linear, 1KΩ, for VGA output and CVBS output respectively)		
	Audio bitrate	64 Kbps		
	Dual-stream	Support		
Stream type	Video, Video & Audio			
Synchronous playback	4-ch	8-ch	16-ch	
Playback resolution	1080p/720p/VGA/WD1/4CIF/CIF/QVGA/QCIF			
Hard disk	Type	8 SATA interfaces for 8 HDDs; 1 eSATA interface		
	Capacity	Up to 6 TB capacity for each disk		
	eSATA	1 eSATA interface		
External interface	Network interface	2; 10 M/100 M/1000 M self-adaptive Ethernet interfaces		
	Serial interface	RS-232, RS-485, Keyboard		
	USB port	3 × USB 2.0		
	Alarm in / out	16/4		
General	Power supply	100 to 240 VAC, 47 to 63 Hz		
	Consumption (without hard disks)	≤ 35 W	≤ 45 W	≤ 65 W
	Working temperature	-10 °C to +55 °C (14 °F to 131 °F)		
	Working humidity	10% to 90%		
	Chassis	19-inch rack-mounted 2U chassis		
	Dimensions (W × D × H)	445 × 470 × 90 mm (17.5 × 18.5 × 3.5 inch)		
Weight (without hard disks)	≤ 8 Kg (17.6 lb)			

Glossary

- **Dual Stream:** Dual stream is a technology used to record high resolution video locally while transmitting a lower resolution stream over the network. The two streams are generated by the DVR, with the main stream having a maximum resolution of 1080P and the sub-stream having a maximum resolution of CIF.
- **DVR:** Acronym for Digital Video Recorder. A DVR is device that is able to accept video signals from analog cameras, compress the signal and store it on its hard drives.
- **HDD:** Acronym for Hard Disk Drive. A storage medium which stores digitally encoded data on platters with magnetic surfaces.
- **DHCP:** Dynamic Host Configuration Protocol (DHCP) is a network application protocol used by devices (DHCP clients) to obtain configuration information for operation in an Internet Protocol network.
- **HTTP:** Acronym for Hypertext Transfer Protocol. A protocol to transfer hypertext request and information between servers and browsers over a network
- **PPPoE:** PPPoE, Point-to-Point Protocol over Ethernet, is a network protocol for encapsulating Point-to-Point Protocol (PPP) frames inside Ethernet frames. It is used mainly with ADSL services where individual users connect to the ADSL transceiver (modem) over Ethernet and in plain Metro Ethernet networks.
- **DDNS:** Dynamic DNS is a method, protocol, or network service that provides the capability for a networked device, such as a router or computer system using the Internet Protocol Suite, to notify a domain name server to change, in real time (ad-hoc) the active DNS configuration of its configured hostnames, addresses or other information stored in DNS.
- **Hybrid DVR:** A hybrid DVR is a combination of a DVR and NVR.
- **NTP:** Acronym for Network Time Protocol. A protocol designed to synchronize the clocks of computers over a network.
- **NTSC:** Acronym for National Television System Committee. NTSC is an analog television standard used in such countries as the United States and Japan. Each frame of an NTSC signal contains 525 scan lines at 60Hz.
- **NVR:** Acronym for Network Video Recorder. An NVR can be a PC-based or embedded system used for centralized management and storage for IP cameras, IP Domes and other DVRs.
- **PAL:** Acronym for Phase Alternating Line. PAL is also another video standard used in broadcast televisions systems in large parts of the world. PAL signal contains 625 scan lines at 50Hz.
- **PTZ:** Acronym for Pan, Tilt, Zoom. PTZ cameras are motor driven systems that allow the camera to pan left and right, tilt up and down and zoom in and out.
- **USB:** Acronym for Universal Serial Bus. USB is a plug-and-play serial bus standard to interface devices to a host computer.

Troubleshooting

- **No image displayed on the monitor after the device is starting up normally.**

Possible Reasons:

- No VGA or HDMI connections.
- Connection cable is damaged.
- Input mode of the monitor is incorrect.

Steps:

1. Verify the device is connected with the monitor via HDMI or VGA cable.
If not, please connect the device with the monitor and reboot.
2. Verify the connection cable is good.
If there is still no image display on the monitor after rebooting, please check if the connection cable is good, and change a cable to connect again.
3. Verify Input mode of the monitor is correct.
Please check the input mode of the monitor matches with the output mode of the device (e.g. if the output mode of DVR is HDMI output, then the input mode of monitor must be the HDMI input). And if not, please modify the input mode of monitor.
4. Check if the fault is solved by the step 1 to step 3.
If it is solved, finish the process.
If not, please contact the engineer from our company to do the further process.

- **There is a beep sound after a new bought device starts up.**

Possible Reasons:

- No HDD is installed in the device.
- The installed HDD has not been initialized.
- The installed HDD is not compatible with the device or is broken-down.

Steps:

1. Verify at least one HDD is installed in the device.
 - 1) If not, please install the compatible HDD.

Please refer to the “Quick Operation Guide” for the HDD installation steps.

 - 2) If you do not want to install a HDD, select “Menu>Configuration > Exceptions”, and uncheck the Audible Warning checkbox of “HDD Error”.
2. Verify the HDD is initialized.
 - 1) Select “Menu>HDD>General”.
 - 2) If the status of the HDD is “Uninitialized”, please check the checkbox of corresponding HDD and click the “Init” button.
3. Verify the HDD is detected or is in good condition.
 - 1) Select “Menu>HDD>General”.
 - 2) If the HDD is not detected or the status is “Abnormal”, please replace the dedicated HDD according to the requirement.
4. Check if the fault is solved by the step 1 to step 3.
 - 1) If it is solved, finish the process.

2) If not, please contact the engineer from our company to do the further process.

- **Live view stuck when video outputs locally.**

Possible Reasons:

- a) The frame rate has not reached the real-time frame rate.

Steps:

1. Check the parameters of Main Stream (Normal) and Main Stream (Event).
Select “Menu > Record > Encoding > Record”, and set the resolution of Main Stream (Event) the same as the one of Main Stream (Normal).
2. Verify the frame rate is real-time frame rate.
Select “Menu > Record > Parameters > Record”, and set the Frame rate to Full Frame.
3. Check if the fault is solved by the above steps.
If it is solved, finish the process.
If not, please contact the engineer from our company to do the further process.

- **When using the device to get the live view audio, there is no sound or there is too much noise, or the volume is too low.**

Possible Reasons:

- a) Cable between the pickup and camera is not connected well; impedance mismatches or incompatible.
- b) The stream type is not set as “Video & Audio”.

Steps:

1. Verify the cable between the pickup and camera is connected well; impedance matches and compatible.
2. Verify the setting parameters are correct.
Select “Menu > Record > Parameters > Record”, and set the Stream Type as “Audio & Video”.
3. Check if the fault is solved by the above steps.
If it is solved, finish the process.
If not, please contact the engineer from our company to do the further process.

- **The image gets stuck when DVR is playing back by single or multi-channel cameras.**

Possible Reasons:

- a) The frame rate is not the real-time frame rate.
- b) The DVR supports up to 16-channel synchronize playback at the resolution of 4CIF, if you want a 16-channel synchronize playback at the resolution of 720p, the frame extracting may occur, which leads to a slight stuck.

Steps:

1. Verify the frame rate is real-time frame rate.
Select “Menu > Record > Parameters > Record”, and set the Frame Rate to “Full Frame”.
2. Verify the hardware can afford the playback.
Reduce the channel number of playback.
Select “Menu > Record > Encoding > Record”, and set the resolution and bitrate to a lower level.
3. Reduce the number of local playback channel.
Select “Menu > Playback”, and uncheck the checkbox of unnecessary channels.
4. Check if the fault is solved by the above steps.
If it is solved, finish the process.
If not, please contact the engineer from our company to do the further process.

- **No record file found in the device local HDD, and the prompt “No record file found” pops up when you search the record files.**

Possible Reasons:

- a) The time setting of system is incorrect.
- b) The search condition is incorrect.
- c) The HDD is error or not detected.

Steps:

1. Verify the system time setting is correct.
Select “Menu > Configuration > General > General”, and verify the “Device Time” is correct.
2. Verify the search condition is correct.
Select “Playback”, and verify the channel and time are correct.
3. Verify the HDD status is normal.
Select “Menu > HDD > General” to view the HDD status, and verify the HDD is detected and can be read and written normally.
4. Check if the fault is solved by the above steps.
If it is solved, finish the process.
If not, please contact the engineer from our company to do the further process.

List of Compatible Hikvision IP Cameras



The IPC connection is not supported by DS-7100 series DVR.

Type	Model	Version	Max. Resolution	Sub-stream	Audio
HD Network Camera	DS-2CD7153-E	V5.1.0 build 131202	1600×1200	√	×
	DS-2CD754F-EI	V5.1.0 build 131202	2048×1536	√	√
	DS-2CD783F-EI	V5.1.0 build 131202	2560×1920	√	√
	DS-2CD7164-E	V5.1.0 build 131202	1280×720	√	×
	DS-2CD864FWD-E	V5.1.0 build 131202	1600×1200	√	√
	DS-2CD4026FWD 14.33	V5.1.0 build5 131202	1920×1080	√	√
	DS-2CD6233F 14.24	V5.1.0 build5 131202	2048×1536	√	×
	DS-2CD2012-I	V5.1.0 build131202	1280×960	√	×
	DS-2CD4012F	V5.1.0 build 131202	1280×1024	√	√
	DS-2CD4232FWD-I	V5.1.0 build 131202	2048×1536	√	√
SD Network Camera	DS-2CD793PFWD-EI	V5.1.0 build 131202	704×576	√	√
Intelligence Traffic Camera	iDS-2CD9122	V3.5.0 build131012	1920×1080	×	×
	iDS-2CD9121	V3.4.2 build 130718	1600×1200	×	×
Network Speed Dome	DS-2DF7274	V5.1.0 build 130923	1280×960	√	√
	DS-2DE7174	V5.0.2Build130926	1280×960	√	√



For the list, our company holds right to interpret.

List of Compatible Third-party IP Cameras



- The IPC connection is not supported by DS-7100 series DVR.
- The ONVIF protocol is not supported by DS-7100 and DS-7200 series DVR

Manufacturer	Model	Version	Max. Resolution	Sub-stream	Audio
Axis	P3304	5.2	1440×900	√	×
Sony	SNC-RH124	1.7.00	1280×720	√	√
Samsung	SND-5080P	3.10_130416	1280×1024	√	√
Vivotek	FD8134	0107a	1280×800	√	×
Bosch	Dinion NBN-921-P	V10500453	1280×720	×	×
Panasonic	SP306H	Application: 1.34 Image Data: 1.06	1280×960	×	√
Cannon	VB-H410	Ver.+1.0.0	1280×960	×	√
Zavio	F3206	MG.1.6.02c045	1920×1080	√	×
Pelco	IX30DN-ACFZHB3	1.8.2-20120327-2.9080-A1.7852	2048×1536	√	×



First Choice for Security Professionals